

KAWAI

STAGE PIANO
MP7SE
Owner's Manual

Introduction

Main Operation

EDIT Menu

STORE Button & SETUPS

Recorder

USB Menu

SYSTEM Menu

Appendix

EN

Thank you for purchasing this Kawai MP7SE stage piano.

This owner's manual contains important information regarding the instrument's usage and operation.

Please read all chapters carefully, keeping this manual handy for future reference.

■ About this Owner's Manual

Before attempting to play this instrument, please read the **Introduction** chapter from page 10 of this owner's manual. This chapter provides a brief explanation of each section of the MP7SE's control panel, an overview of its various jacks and connectors, and details how the components of the instrument's sound are structured.

The **Main Operation** chapter (page 20) provides an overview of the instrument's most commonly used functions, beginning with turning zones on and off, adjusting their volume, and selecting sounds. Later on, this chapter introduces basic sound adjustment using the four control knobs, before examining how reverb, EFX, and amp simulation can all be applied to dramatically change the character of the selected sound. Next, the MP7SE's authentic Tonewheel Organ mode is outlined, explaining how to adjust drawbar positions using zone faders and control knobs, and change the organ's percussion characteristics. The chapter closes with an explanation of the instrument's global EQ and transpose functions.

The **EDIT Menu** chapter (page 38) lists all available INT mode and EXT mode parameters by category for convenient reference. The **STORE Button & SETUP Menus** chapter (page 64) outlines storing customised sounds, capturing the entire panel configuration as a SETUP, then recalling different SETUPS from the MP7SE's internal memory.

The **Recorder** chapter (page 68) provides instructions on how to record and play back pieces stored both in the instrument's internal memory, and also MP3/WAV audio files saved to USB memory devices. This chapter also explains the MP7SE's metronome/drum pattern functions. Additional USB functions are covered in greater detail in the **USB Menu** chapter (page 99), while the **SYSTEM Menu** chapter (page 105) explains the MP7SE's system settings and various reset functions.

Finally, the **Appendix** section (page 119) includes USB-MIDI driver information, software update instructions and listings of the instrument's internal sounds, drum rhythms, effects, MIDI reference information, and full specification details.

Important Safety Instructions

SAVE THESE INSTRUCTIONS

INSTRUCTIONS PERTAINING TO A RISK OF FIRE, ELECTRIC SHOCK, OR INJURY TO PERSONS



WARNING

TO REDUCE THE RISK OF FIRE OR ELECTRIC SHOCK, DO NOT EXPOSE THIS PRODUCT TO RAIN OR MOISTURE.

AVIS : RISQUE DE CHOC ELECTRIQUE - NE PAS OUVRIR.

TO REDUCE THE RISK OF ELECTRIC SHOCK, DO NOT REMOVE COVER (OR BACK). NO USER-SERVICEABLE PARTS INSIDE. REFER SERVICING TO QUALIFIED SERVICE PERSONNEL.



The lightning flash with arrowhead symbol, within an equilateral triangle, is intended to alert the user to the presence of uninsulated "dangerous voltage" within the product's enclosure that may be of sufficient magnitude to constitute a risk of electric shock to persons.



The exclamation point within an equilateral triangle is intended to alert the user to the presence of important operating and maintenance (servicing) instructions in the literature accompanying the product.

Examples of Picture Symbols



denotes that care should be taken. The example instructs the user to take care not to allow fingers to be trapped.



denotes a prohibited operation. The example instructs that disassembly of the product is prohibited.



denotes an operation that should be carried out. The example instructs the user to remove the power cord plug from the AC outlet.

Read all the instructions before using the product.

- 1) Read these instructions.
- 2) Keep these instructions.
- 3) Heed all warnings.
- 4) Follow all instructions.
- 5) Do not use this apparatus near water.
- 6) Clean only with dry cloth.
- 7) Do not block any ventilation openings. Install in accordance with the manufacturer's instructions.
- 8) Do not install near any heat sources such as radiators, heat registers, stoves, or other apparatus (including amplifiers) that produce heat.
- 9) Do not defeat the safety purpose of the polarized or grounding-type plug. A polarized plug has two blades with one wider than the other. A grounding type plug has two blades and a third grounding prong. The wide blade or the third prongs are provided for your safety. If the provided plug does not fit into your outlet, consult an electrician for replacement of the obsolete outlet.
- 10) Protect the power cord from being walked on or pinched particularly at plugs, convenience receptacles, and the point where they exit from the apparatus.
- 11) Only use attachments/accessories specified by the manufacturer.
- 12) Use only with the cart, stand, tripod, bracket, or table specified by the manufacturer, or sold with the apparatus. When a cart is used, use caution when moving the cart/apparatus combination to avoid injury from tip-over. 
- 13) Unplug this apparatus during lightning storms or when unused for long periods of time.
- 14) Refer all servicing to qualified service personnel. Servicing is required when the apparatus has been damaged in any way, such as power-supply cord or plug is damaged, liquid has been spilled or objects have fallen into the apparatus, the apparatus has been exposed to rain or moisture, does not operate normally, or has been dropped.

When using electrical products, the following basic precautions should always be followed:



WARNING

Indicates a potential hazard that could result in death or serious injury if the product is handled incorrectly.

The product should be connected to an AC outlet of the specified voltage.



- If you are going to use an AC power cord, make sure that its has the correct plug shape and conforms to the specified power voltage.
- Failure to do so may result in fire.

Do not insert or disconnect the power cord plug with wet hands.



Doing so may cause electric shock.

Take care not to allow any foreign matter to enter the product.

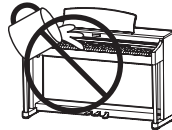

Entry of water, needles or hair pins may result in breakdown or short-circuit. The product shall not be exposed to dripping or splashing. No objects filled with liquids, such as vases, shall be placed on the product.

When using the headphones, do not listen for long periods of time at high volume levels.

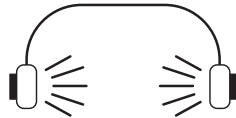

Doing so may result in hearing problems.

Do not disassemble, repair or modify the product.

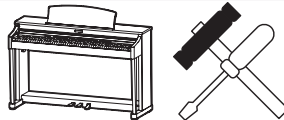

Doing so may result in product breakdown, electric shock or short-circuit.

When disconnecting the AC power cord's plug, always hold the plug and pull it to remove it.



- Pulling the AC power cord itself may damage the cord, causing a fire, electric shock or short-circuit.

The product is not completely disconnected from the power supply even when the power switch is turned off. If the product will not be used for a long time, unplug the AC power cord from the AC outlet.



- Failure to do so may cause fire in case of lightning.
- Failure to do so may over-heat the product, resulting in fire.

It is good practice to place the instrument near the AC outlet and the power cord plug in a position so that it can readily be disconnected in an emergency because electricity is always charging while the plug is in the AC outlet even in a power switch off condition.

Ensure that this product is connected to a socket with a protective earth connection.

GROUNDING INSTRUCTIONS

This product must be grounded. If it should malfunction or breakdown, grounding provides a path of least resistance for electric current to reduce the risk of electric shock. This product is equipped with a cord having an equipment-grounding conductor and a grounding plug. The plug must be plugged into an appropriate outlet that is properly installed and grounded in accordance with all local codes and ordinances.

DANGER - Improper connection of the equipment-grounding conductor can result in a risk of electric shock. Check with a qualified electrician or serviceman if you are in doubt as to whether the product is properly grounded. Do not modify the plug provided with the product - if it will not fit the outlet, have a proper outlet installed by a qualified electrician.



CAUTION

Indicates a potential hazard that could result in injury or damage to the product or other property if the product is handled incorrectly.

Do not use the product in the following areas.

- Areas, such as those near windows, where the product is exposed to direct sunlight
- Extremely hot areas, such as near a heater
- Extremely cold areas, such as outside
- Extremely humid areas
- Areas where a large amount of sand or dust is present
- Areas where the product is exposed to excessive vibrations

Using the product in such areas may result in product breakdown. Use the product only in moderate climates (not in tropical climates).

Before connecting cords, make sure that the power to this product and other devices is turned OFF.

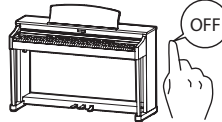

Failure to do so may cause breakdown of this product and other devices.

Do not drag the product on the floor. Take care not to drop the product.

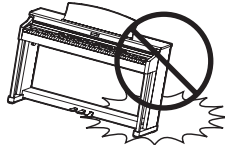

Please lift up the product when moving it. Please note that the product is heavy and must be carried by more than two persons. Dropping the product may result in breakdown.

Do not place the product near electrical appliances such as TVs and radios.

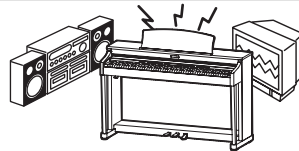

- Doing so may cause the product to generate noise.
- If the product generates noise, move the product sufficiently away from the electrical appliance or connect it to another AC outlet.

When connecting the AC power cord and other cords, take care not to get them tangled.



Failure to do so may damage them, resulting in fire, electric shock or short-circuit.

Do not wipe the product with benzene or thinner.



- Doing so may result in discoloration or deformation of the product.
- When cleaning the product, put a soft cloth in lukewarm water, squeeze it well, then wipe the product.

Do not stand on the product or exert excessive force.



- Doing so may cause the product to become deformed or fall over, resulting in breakdown or injury.

Do not place naked flame, such as lighted candles on the product.

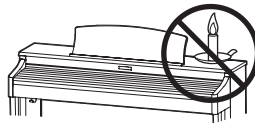

Doing so may cause the illumination to fall over, resulting in fire.

Ensure that the ventilation is not impeded by covering the ventilation openings with items, such as newspaper, table-cloths, curtains, etc.

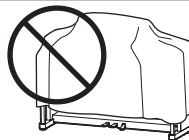

Failure to do so may over-heat the product, resulting in fire.

The product should be located so that its location or position does not interfere with its proper ventilation. Ensure a minimum distance of 5cm around the product for sufficient ventilation.

The product should be serviced by qualified service personnel when:

- The power supply cord or the plug has been damaged.
- Objects have fallen, or liquid has been spilled into the product.
- The product has been exposed to rain.
- The product does not appear to operate normally or exhibits a marked change in performance.
- The product has been dropped, or the enclosure damaged.

Notes on Repair

Should an abnormality occur in the product, immediately turn the power OFF, disconnect the power cord plug, and then contact the shop from which the product was purchased.

Instruction for AC power cord (U.K.)

WARNING: THIS APPARATUS MUST BE EARTHED

IMPORTANT: The wires in this mains lead are coloured in accordance with the following code:

- GREEN-AND-YELLOW: EARTH
- BLUE: NEUTRAL
- BROWN: LIVE

As the colours of the wires in the mains lead of this apparatus may not correspond with the coloured markings identifying the terminals in your plug, proceed as follows.

- The wire which is coloured GREEN-AND-YELLOW must be connected to the terminal in the plug which is marked by the letter E or by the safety earth symbol or coloured GREEN or GREEN-AND-YELLOW.
- The wire which is coloured BLUE must be connected to the terminal which is marked with the letter N or coloured BLACK.
- The wire which is coloured BROWN must be connected to the terminal which is marked with the letter L or coloured RED.



An information on Disposal for users

If your product is marked with this recycling symbol it means that, at the end of its life, you must dispose of it separately by taking it to an appropriate collection point. You should not mix it with general household waste. Disposing of this product correctly will prevent potential negative effects on the environment and human health which could otherwise arise due to inappropriate waste handling. For further details, please contact your local authority. (European Union only)

FCC Information (U.S.A)

CAUTION: Changes or modifications not expressly approved by the party responsible for compliance could void the user's authority to operate the equipment.

NOTE: This equipment has been tested and found to comply with the limits for a Class B digital device, pursuant to Part 15 of the FCC Rules. These limits are designed to provide reasonable protection against harmful interference in a residential installation. This equipment generates, uses and can radiate radio frequency energy and, if not installed and used in accordance with the instructions, may cause harmful interference to radio communications. However, there is no guarantee that interference will not occur in a particular installation. If this equipment does cause harmful interference to radio or television reception, which can be determined by turning the equipment off and on, the user is encouraged to try to correct the interference by one or more of the following measures:

- Reorient or relocate the receiving antenna.
- Increase the separation between the equipment and receiver.
- Connect the equipment into an outlet on a circuit different from that to which the receiver is connected.
- Consult the dealer or an experienced radio/TV technician for help.



Declaration of Conformity

Products:	Electronic Piano
Model Number:	MP7SE
Responsible Party Name:	Kawai America Corporation
Address:	2055 East University Drive, Rancho Dominguez, CA 90220
Telephone:	310-631-1771

This device complies with Part 15 of the FCC Rules. Operation is subject to the following two conditions:
(1) this device may not cause harmful interference, and
(2) this device must accept any interference received, including interference that may cause undesired operation.

This applies only to products distributed by Kawai America Corporation.

Table of Contents

Important Safety Instructions	4
Table of Contents	8

Introduction

Welcome to the MP7SE	10
1. Feature Highlights	10
2. Owner's Manual Conventions	11
Part Names & Functions	12
1. Front Panel: Knobs, Faders & Buttons	12
2. Front Panel: Jacks & Connectors	16
3. Rear Panel: Jacks & Connectors	16
Connecting to Other Devices	18
Understanding the MP7SE	19

Main Operation

Getting Started	20
Selecting Sounds	21
Zone Functions	22
1. Zone Basics	22
2. Zone Modes (int/ext/both)	23
3. Zone Key Range	24
LCD Display & Control Knobs	26
Effects Section	27
1. Reverb	27
2. EFX	28
3. Amp Simulator (MAIN zone only)	30
Tonewheel Organ Mode	32
Global Section	34
1. EQ	34
2. Transpose	36
3. Local Off	37

EDIT Menu

Overview of the EDIT Menu (INT mode)	38
EDIT Menu parameters (INT mode)	40
1. Reverb	40
2.1. EFX	40
2.2. Amp Simulator (MAIN zone)	41
3. Sound	42
4. Tuning	45
5. Key Setup	46
6. Controllers	49
7. Knob Assign	51
8. Virtual Technician (PIANO sounds)	52
Virtual Technician (E.PIANO, HARPSICHORD, BASS sounds)	53
Virtual Technician (DRAWBAR sounds)	53
Overview of the EDIT Menu (EXT mode)	54
EDIT Menu parameters (EXT mode)	56
1. Channel/Program	56
2. SETUP	56
3. Transmit EFX	57
4. MMC EFX	57
5. Key Setup	58
6. Controllers	60
7. Knob Assign	62
Overview of the EDIT Menu (BOTH mode)	63

STORE Button & SETUPS

Overview of the STORE Button	64
1. Storing a SOUND	64
2. Storing a SETUP	65
3. Storing POWERON settings	66
SETUP Memories	67

Recorder

Overview of the Recorder	68
Song Recorder (Internal memory)	69
1. Recording a song	69
2. Playing back a song	71
3. Saving a song as an SMF file	73
4. Loading an SMF file into memory	74
5. Erasing a song	77
6. Song Transpose	78
7. Panel Mode	78
8. MIDI to Audio	78
9. SMF Direct Play	79
SMF Mixer	80
Audio Record/Playback (USB memory)	81
1. Recording an audio file	81
2. Playing an audio file	84
3. Overdubbing an audio file	87
4. MIDI to Audio	90
Metronome	93
1. Click mode	93
2. Rhythm mode	94
3. Recording with the metronome	97

USB Menu

Overview of the USB Menu	99
USB Menu Functions	100
1. Load	100
2. Save	101
3. Delete	102
4. Rename	103

SYSTEM Menu

Overview of the SYSTEM Menu	105
SYSTEM Menu Parameters & Functions	106
1. Utility	106
2. Pedal/Mod.	108
Expression pedal calibration	109
3. MIDI	110
4. Offset	111
5. User Edit	111
Creating a User Touch Curve	112
Creating a User Temperament	113
Creating a User Key Volume	114
Creating a User Stretch Tuning	115
Creating a User Voicing	116
6. Reset	117
Panic button	117
Panel Lock (🔒)	118

Appendix

Troubleshooting	119
USB MIDI (USB to Host connector)	124
Software Update	125
Sound List	126
Rhythm Pattern List	127
EFX Categories, Types, & Parameters	128
Specifications	133
MIDI Implementation	134
1. Recognised Data	135
2. Transmitted Data	139
3. Exclusive Data	141
4. SOUND/SETUP Program/Bank	153
5. Program Change Number List	154
6. Control Change Number (CC#) Table	157
MIDI Implementation Chart	158

1 Feature Highlights

'Responsive Hammer III' weighted-key action, with Ivory Touch key surfaces and Let-off simulation

The MP7SE's *Responsive Hammer III* (RH III) keyboard action recreates the distinctive touch of an acoustic grand piano, with its realistic movement and accurate 3-sensor technology providing a smooth, natural, and highly responsive piano playing experience. The weight of the keyboard is appropriately graded to mirror the heavier bass hammers and lighter treble hammers of an acoustic piano, while structural reinforcements within the action assembly ensure greater stability during fortissimo and staccato passages.

The *RH III* keyboard action also reproduces the subtle *let-off* sensation felt when playing the keys of a grand piano very softly, enhancing delicate pianissimo playing to satisfy the expectations of even the most discerning pianists. Finally, the MP7SE keyboard action features Kawai's *Ivory Touch* key surfaces as standard. This finely textured material gently absorbs moisture to assist playing control, and possesses a natural, matte finish that is smooth, but not slippery.

The ultimate pianos for Concert, Pop, and Jazz

The MP7SE captures the beautiful sound of Kawai's SK-EX, EX, and SK-5 acoustic grand pianos, with all 88 keys of these exceptional instruments meticulously recorded, analysed and faithfully reproduced using proprietary *Harmonic Imaging™* technology. This unique process accurately recreates the broad dynamic range of the original grand pianos, affording pianists an extraordinary level of expressiveness ranging from the softest pianissimo to the strongest, boldest fortissimo.

With separate categories for Concert, Pop, and Jazz playing, the MP7SE offers an excellent selection of high quality acoustic piano sounds suitable for various musical styles, including separate sub-categories for upright and mono pianos.

Moreover, Kawai's unique *Virtual Technician* feature allows various characteristics of the selected acoustic piano sound to be shaped at the touch of a button or the turn of a knob, with parameters to adjust voicing and regulation, string and damper resonances, and subtle hammer, damper, and key release noises.

Vintage EPs, twin effects, and amp simulation

The MP7SE also features an excellent selection of vintage electric piano sounds, each with their own distinctive characteristics. Enjoy their natural, organic sound, or pass the signal through a wide variety of classic effects stomp boxes, before plugging into one of the five classic amp and speaker cabinets – complete with realistic microphone character and position modelling.

Classic tonewheel organs with drawbar control and authentic percussion

The MP7SE's brand new tonewheel organ simulation transforms the stage piano into a vintage electromechanical organ, complete with nine real-time adjustable drawbars and authentic percussion controls. Organ enthusiasts can dial-in favourite drawbar registrations, adjust the 'condition' of the organ tone, and select their preferred rotary speaker character, then store the sound to memory for immediate recall. With organ mode selected, the MP7SE adjusts the strike point for the keyboard, allowing blazing runs and greasy licks to be played on its fully-weighted action as easily as the real thing.

High quality strings, pads, brasses, basses and more

Supplementing the realistic acoustic pianos, vintage electric pianos, and growling tonewheel organs, the MP7SE features a broad range of high quality strings, pads, synths, brass and woodwind voices, basses, guitars, and a whole host of other useful sounds. These supplementary sounds are ideal for building layers, adding texture to other instruments, or for playing individually, at the front of the mix. And if the stock sound isn't quite perfect, feel free to customise and tweak using the MP7SE's flexible ADSR parameters and resonance/cut-off controls – all immediately accessible directly from the panel.

Four zone master keyboard controller

The MP7SE maintains the MP series' classic four-zone approach, with each zone able to play internal sounds, external MIDI devices, or both types simultaneously. Zones can be played individually, or freely split, layered and velocity switched to create stunning personalised performances. The MP7SE's powerful customisation allows parameters and settings for each zone to be adjusted and controlled independently, making for an unbelievably versatile all-in-one performance instrument.

Intuitive operation, large LCD, real-time assignable control knobs

The MP7SE's control panel is clearly arranged and easy to use, with related functions grouped together and placed where you'd expect to find them. A large LCD display and four assignable control knobs, allow several parameters to be adjusted directly in real-time, without getting lost in menus – concentrate on playing, rather than trying to remember which button does what.

256 Setup memories: enough for the busiest stage musician

The MP7SE allows every single customised sound, knob position, fader level, and adjustable parameter to be stored in memory as a SETUP, and recalled at the touch of a button. With over 250 SETUP memories, the MP7SE is ideal for busy stage musicians who like to plan several shows ahead, before going out on the road.

USB to Device functionality, with MP3/WAV/SMF file recording and playback

The MP7SE is equipped with USB connectors that not only allow the instrument to be connected to a computer for MIDI use, but also to load and save data to USB memory devices directly. This 'USB to Device' feature allows customised sounds, SETUP memories, and recorder songs stored in internal memory to be saved to USB for posterity.

USB memory devices can also be used to play back MP3 or WAV audio or SMF MIDI files, allowing performing musicians to play along with professional backing tracks, or simply learn the chords or melody for a new piece. It is even possible to save performances directly as MP3, WAV, or SMF files for emailing to band members, casual listening away from the keyboard, or further editing using an audio workstation.

2 Owner's Manual Conventions

This owner's manual utilises a number of illustrative conventions in order to explain the MP7SE's various functions. The examples below provide an overview of the button LED indicator states and press types, and the appearance of different kinds of explanation text.

■ Button LED indicator states

ON / OFF



LED indicator OFF:

Sound/Function is not selected.

ON / OFF



LED indicator ON:

Sound/Function is selected.

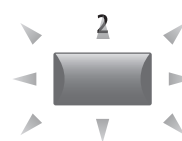

LED indicator flashing:

Sound/Function is selected in a temporary state.

■ Button press types

EQ



Normal press:

Select a sound or function, or turn a function ON/OFF.

EQ



Press and hold:

Show a function's parameters.

MAIN

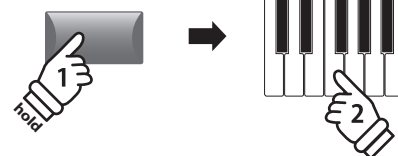

Press and hold, then press X:

Set split points, create zone ranges, set transpose key, etc.

■ Text appearance

Normal instruction and explanation text is written in regular type at 9 pt. size.

* Notes about functions are marked with an asterisk and written in 7.5 pt. size.

Reminders, hints, and additional explanations are written in italic type at 9 pt. size.

— **Captions explaining the LCD display or button functions, are written in bold type at 8.5 pt. size.**

Example operations are written in italic type at 8 pt. size, and enclosed within a grey box.

Part Names & Functions

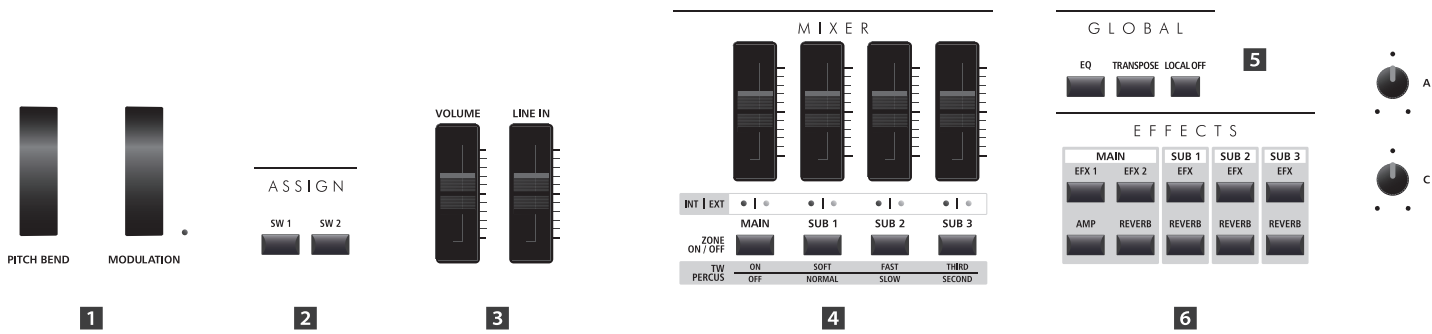

1 Front Panel: Knobs, Faders & Buttons

1 Control Wheels

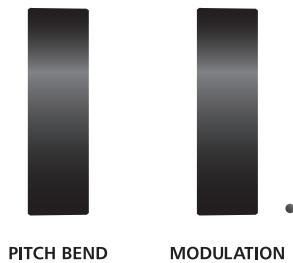

PITCH BEND wheel

This control wheel smoothly bends the pitch up or down from its current value.

MODULATION wheel

This control wheel controls the modulation (vibrato) depth. Moving the wheel forward increases the vibrato depth. The LED indicator will turn ON when this wheel is in use.

* Alternative functions can be assigned to the MODULATION wheel in the Controllers page of the EDIT menu (page 49).

2 ASSIGN Buttons



SW1 / SW2 buttons

These buttons turn user-assigned functions ON or OFF. Various different functions can be assigned to these buttons, allowing immediate control during performances.

* Press and hold either button to show the respective assign parameters of the EDIT menu in the LCD display.

* For more information about assigning functions, please refer to page 49.

3 Volume Faders

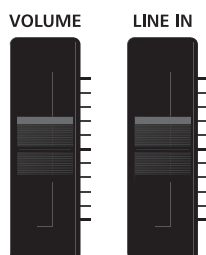

MASTER VOLUME fader

This fader controls the volume level of the MP7SE's OUTPUT and HEADPHONE jacks.

LINE IN fader

This fader controls the LINE IN volume level.

* The LINE IN volume level can be further adjusted by using the Input Level parameter in the Utility page of the SYSTEM menu. For more information, please refer to page 107.

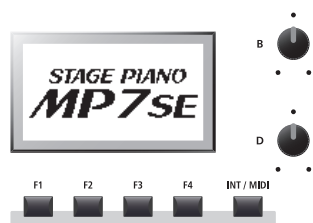

7

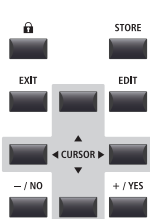

8

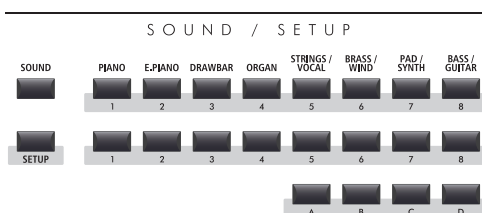

9

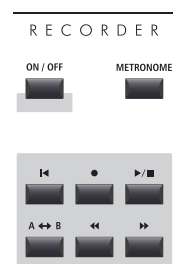

10



11

4 MIXER Section

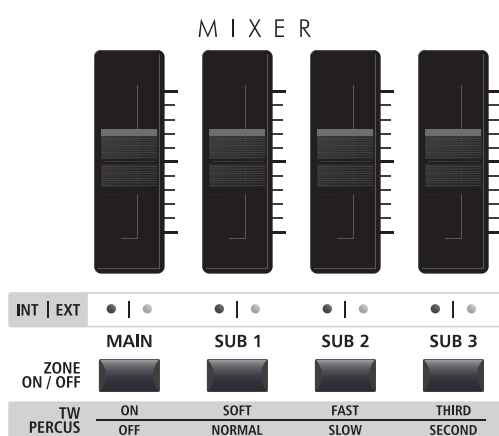

VOLUME faders

These faders control the individual volume levels of the MAIN, SUB1, SUB2, and SUB3 zones. When multiple zones are active, these faders can be used as an audio mixer.

When the tonewheel organ mode is selected, these faders are used to adjust the position of the assigned drawbars.

INT/EXT LEDs

These LEDs indicate whether a zone is controlling an internal sound, an external MIDI device, or both simultaneously.

ZONE ON/OFF buttons

These buttons turn the MAIN, SUB1, SUB2, and SUB3 zones ON or OFF.

When the tonewheel organ mode is selected, these buttons are used to change the percussion characteristics of the organ.

* When the key range is set, the LED indicator for the zone button will also turn green.

* Press and hold each zone button to show the respective key range setting pop-up in the LCD display.

5 GLOBAL Section



EQ button

This button turns the global EQ ON or OFF.

* Press and hold this button to show the EQ settings in the LCD display.

TRANSPOSE button

This button turns the TRANSPOSE function ON or OFF.

* Press and hold this button to show the transpose settings pop-up in the LCD display.

LOCAL OFF

This button disables the internal connection between the MP7SE's keyboard and tone generators.

6 EFFECTS Section

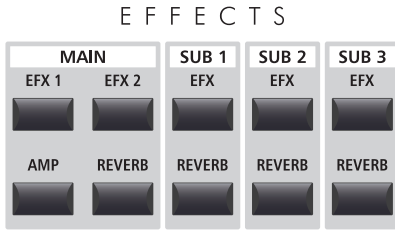

* Press and hold each button to show the respective settings pages of the EDIT menu in the LCD display.

EFX1/EFX2/EFX buttons

These buttons turn the effects for each zone ON or OFF. The MAIN zone has two effect modules, while the SUB1, SUB2, and SUB3 zones have one effect module each.

AMP button

This button turns the amp simulator for the MAIN zone ON or OFF.

REVERB buttons

These buttons turn the reverb for each zone ON or OFF.

7 DISPLAY Section



LCD Display

The LCD display provides a visual indication of the selected zone and sound, parameter values, and the status of other functions when active.

A/B/C/D control knobs

These knobs adjust displayed parameter values in real-time.

* EDIT menu parameters can be freely assigned to each of the four knobs in the Knob Assign page of the EDIT menu (page 51).

F1/F2/F3/F4 buttons

These buttons select the four zones (MAIN, SUB1, SUB2, SUB3) to be displayed and controlled. In other modes (e.g. Recorder) these buttons also select additional functions.

INT / MIDI button

This button is used in conjunction with the +/YES or -/NO buttons to change the zone mode (INT, EXT, or BOTH).

8 EDIT Section

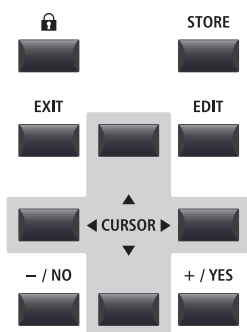

LOCK (🔒) button

This button locks the MP7SE's control panel, thus preventing any accidental button pushes during a performance.

STORE button

This button stores edited SOUNDS, or full panel settings to the SETUP and POWERON memories.

EXIT button

This button exits the current mode or page.

EDIT button

This button enters the EDIT menu. When the EDIT menu is displayed, this button also enters the selected parameter category page.

CURSOR buttons

These buttons move the selection cursor and scroll through the various pages of the EDIT menu.

- / NO + / YES buttons

These buttons decrease or increase the value of the selected parameter, and also cancel or confirm operations that require user interaction (e.g. Erasing data).

9 SOUND / SETUP Section

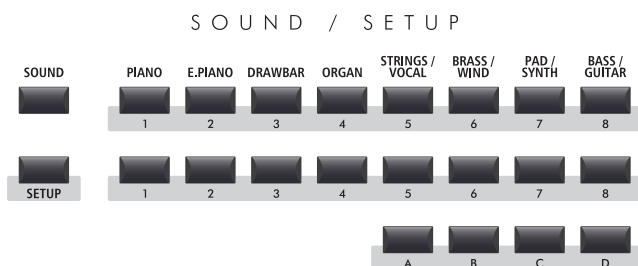

SOUND button

This button sets the MP7SE to SOUND mode, whereby the buttons on the right will select the instrument's 256 internal sounds.

SETUP button

This button sets the MP7SE to SETUP mode, whereby the buttons on the right will select the instrument's 256 SETUP memories.

* Press this button while in SETUP mode to show the SETUP summary pop-up in the LCD display.

SOUND/SETUP SELECTION buttons

In SOUND mode, these buttons select the category, type, and variation of the zone's sound. In SETUP mode, these buttons select the bank and memory used for the SETUP.

10 RECORDER Section

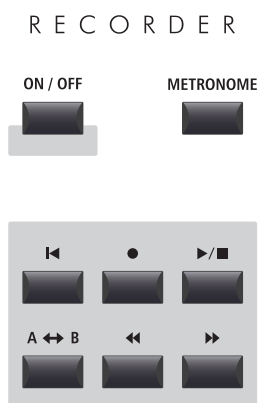

ON/OFF button

This button turns the RECORDER section ON or OFF.

METRONOME button

This button activates the METRONOME or RHYTHM patterns.

◀ (RESET) button

This button resets the MP7SE's song recorder, rewinding songs and MP3/WAV/SMF files to the beginning.

● (RECORD) and ▶/■ (PLAY/STOP) buttons

These buttons record and playback/stop songs stored in the MP7SE's internal memory, or MP3/WAV files saved to a USB memory device.

A ↔ B (LOOP) button

This button activates the MP7SE's A-B Loop function, allowing passages of a recorder song or MP3/WAV/SMF file to be played back repeatedly.

◀◀ (REW) and ▶▶ (FWD) buttons

These buttons are used to move the playing position of the current recorder song or MP3/WAV/SMF backward or forward.

11 SETTING Section

SETTING



PANIC button

This button returns the MP7SE to the Power On state, and also sends All Note Off and Reset All Controller messages via MIDI.

SYSTEM button

This button enters the SYSTEM menu, allowing many aspects of the MP7SE's functionality to be adjusted.

USB button

This button enters the USB menu, allowing data to be loaded and saved from/to a connected USB memory device.

2 Front Panel: Jacks & Connectors



HEADPHONE jack

The headphone jack is located at the left end of the key slip and used to connect a pair of headphones equipped with a standard 1/4" phone jack.



USB TO DEVICE port

The USB to Device port is located at the right end of the key block and used to connect a FAT or FAT32 formatted USB memory device to load and save data.

* Please note that wireless flash memory devices are not compatible with the MP7SE.

3 Rear Panel: Jacks & Connectors

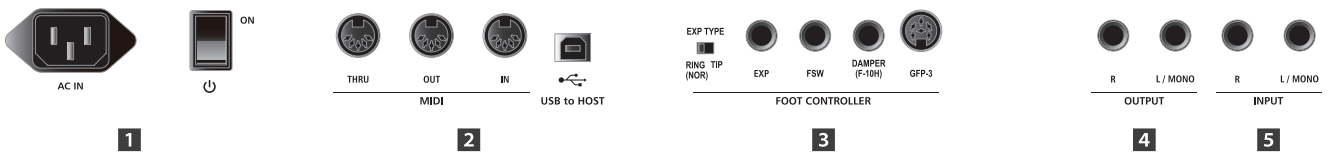

1 POWER Section



AC IN

Connect the power cable included with the MP7SE to this receptacle.

POWER SWITCH

This switch turns the MP7SE ON and OFF.

* The MP7SE features a power saving mode that can turn off the instrument automatically after a specified period of inactivity. For more information, please refer to page 107.

2 MIDI Section

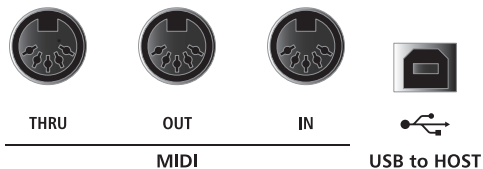

MIDI THRU/OUT/IN jacks

These jacks are used to connect the MP7SE to external MIDI devices, and also to a computer with a MIDI interface as an alternative to the 'USB to Host' port.

USB TO HOST port

This port is used to connect the MP7SE to a computer using a USB cable. When connected, the instrument can be used as a standard MIDI device, allowing it to send a receive MIDI data. Connect a 'B' type USB connector to the instrument, and an 'A' type USB connector to the computer.

* The instrument's USB MIDI port and MIDI IN/OUT jacks can be connected and used simultaneously. To adjust MIDI routing, please refer to the MIDI parameters in the SYSTEM menu, explained on page 110.

* When connecting the MP7SE to a computer using the 'USB to Host' port, additional driver software may be required. For more information, please refer to page 124.

3 FOOT CONTROLLER Section

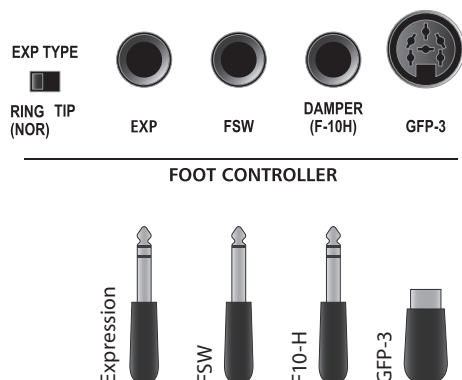

EXP type	Description
RING (NOR)	TRS plug's Ring to WIPER
TIP	TRS plug's Tip to WIPER

* Functions can be freely assigned to each foot controller in the Controllers page of the EDIT menu. For more information, please refer to page 49.

* For more information about purchasing the GFP-3 triple pedal accessory, please contact your local Kawai distributor.

EXP TYPE switch

This switch is used to select the EXP pedal's TRS connector type.

EXP jack

This jack is used to connect an expression pedal to the MP7SE.

* For information about calibrating the expression pedal to ensure correct operation with the MP7SE, please refer to page 109.

FSW jack

This jack is used to connect a momentary foot switch pedal to the MP7SE.

* If the foot switch pedal is not turned off when releasing it, check the FSW polarity. Please refer to page 108.

DAMPER (F-10H) jack

This jack is used to connect the included F-10H damper pedal to the MP7SE.

GFP-3 jack

This jack is used to connect the optional Kawai GFP-3 triple pedal accessory to the MP7SE.

■ Kawai GFP-3 triple pedal accessory: default pedal assignments

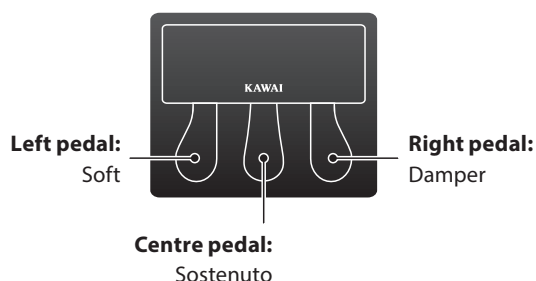

By default, with the optional GFP-3 triple pedal unit connected, the right pedal acts as a damper pedal, the centre pedal acts as a sostenuto pedal, and the left pedal functions as a soft pedal.

* Functions can be freely assigned to each foot controller in the Controllers page of the EDIT menu. For more information, please refer to page 49.

4 OUTPUT Section

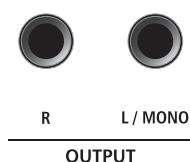

OUTPUT jacks

These jacks are used to connect the MP7SE to a musical instrument amplifier, PA system, or recording console using standard 1/4" phone jacks. To output a mono signal, connect the cable to the L/MONO jack.

5 INPUT Section

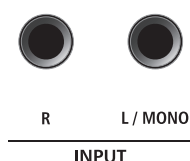

INPUT jacks

These jacks are used to connect a pair of stereo outputs from other electronic instruments or audio equipment to the MP7SE. The input level can be easily adjusted using the LINE IN fader. When connecting a mono audio source, connect the cable to the L/MONO jack only.

* When using the Audio Recorder function, the INPUT audio will also be recorded to the WAV/MP3 file. For more information, please refer to page 81.

Connecting to Other Devices

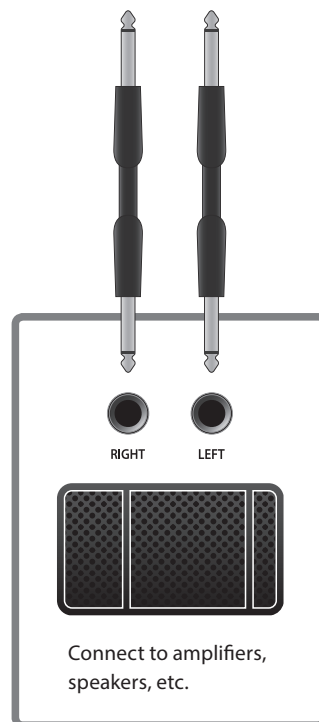
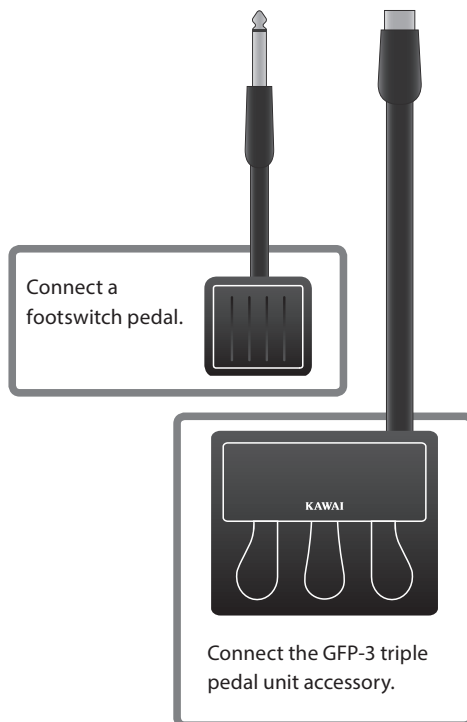
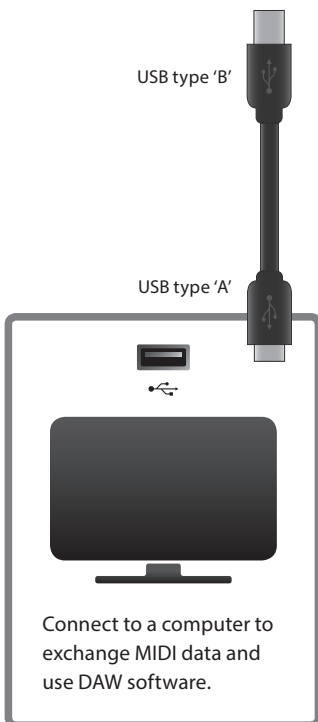
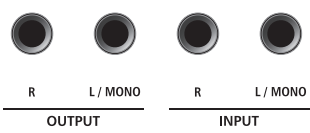
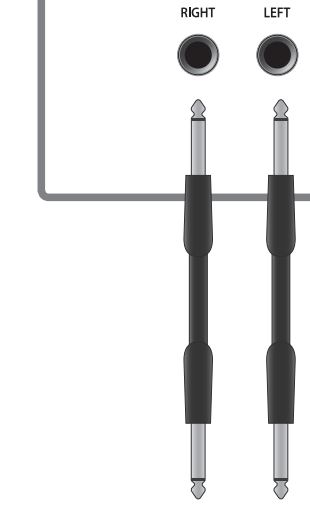
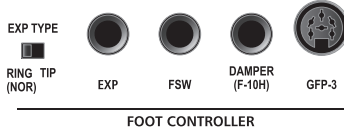
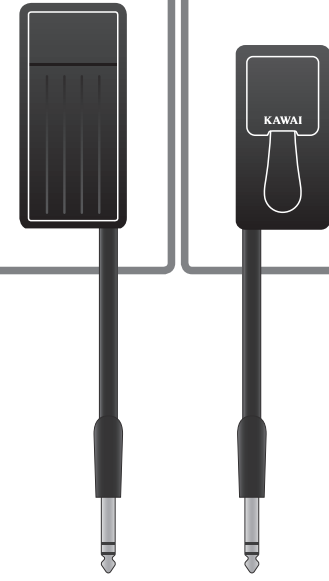
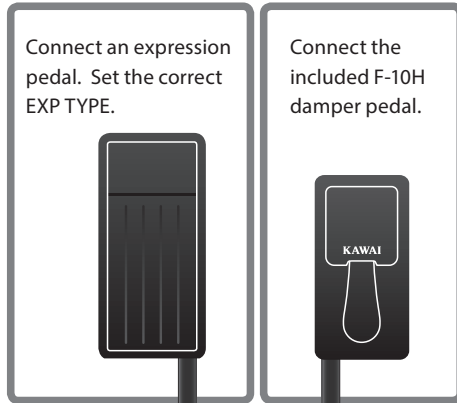
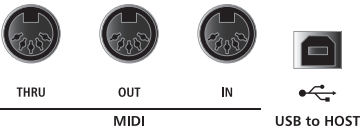
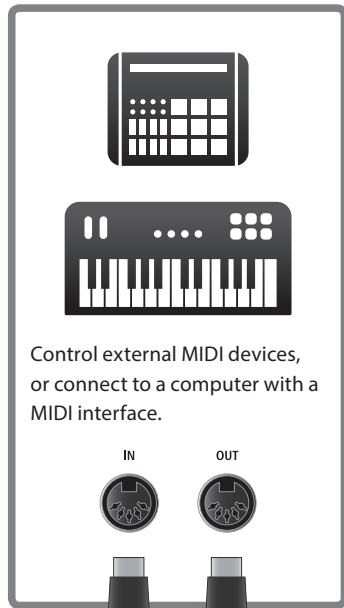

Understanding the MP7SE

■ Preparation before use

The MP7SE does not feature built-in speakers. Therefore, in order to listen to the MP7SE, it will first be necessary to connect a mixer, keyboard amplifier, or headphones to the instrument.

Once connected to an audio output device, press the POWER SWITCH located on the right of the rear panel to turn on the MP7SE. It is recommended to turn on the MP7SE before the audio output device in order to avoid the unpleasant switching noise that can sometimes occur.

■ MP7SE zone structure: explanation

The MP7SE features 4 zones: MAIN, SUB1, SUB2, and SUB3. Each zone features a dedicated VOLUME fader and can be turned ON or OFF freely. Zones can be set to INT (play the MP7SE's internal sounds), EXT (control external MIDI devices) or INT and EXT simultaneously.

When a zone is set to INT, the process of selecting and assigning sounds is largely identical for each zone. However, there are some important differences between the MAIN zone and three SUB zones. First, the MAIN zone features two separate EFX modules and an additional AMP simulator, while the SUB zones each feature one EFX module only. Moreover, the MAIN zone allows any of the 129 effects to be assigned to both EFX modules, however the variety of effects available to the SUB zones' EFX modules is limited to 22 effects. Finally, the MP7SE's tonewheel organ mode can only be used with the MAIN zone is selected, thus the SUB zones are limited to using the standard PCM organ sounds. All sounds are adjusted using the various parameters in the EDIT menu, with additional 'Feature Parameters' that are specific to certain sounds.

REVERB settings are common for all zones, however the depth parameter can be controlled independently for each zone. The MP7SE's EQ is also common for all zones, however parameters in the EDIT menu allow the tonal character for each zone's sound to be adjusted independently.

When set to EXT, zones are used to control external MIDI devices. The MAIN and SUB zones share the same MIDI capabilities, allowing up to four MIDI channels to be independently controlled at the same time. As with INT mode, various parameters to define transmit/receive channels, MMC features, keyboard ranges, and knob assignments can be accessed for each EXT zone via the EDIT menu.

Modifications to each sound can be stored as individual SOUND presets, while the entire configuration of the MP7SE itself can be stored in one of the 256 SETUP memories.

■ MP7SE zone structure: block diagram

The diagram below illustrates the zone structure of the MP7SE.

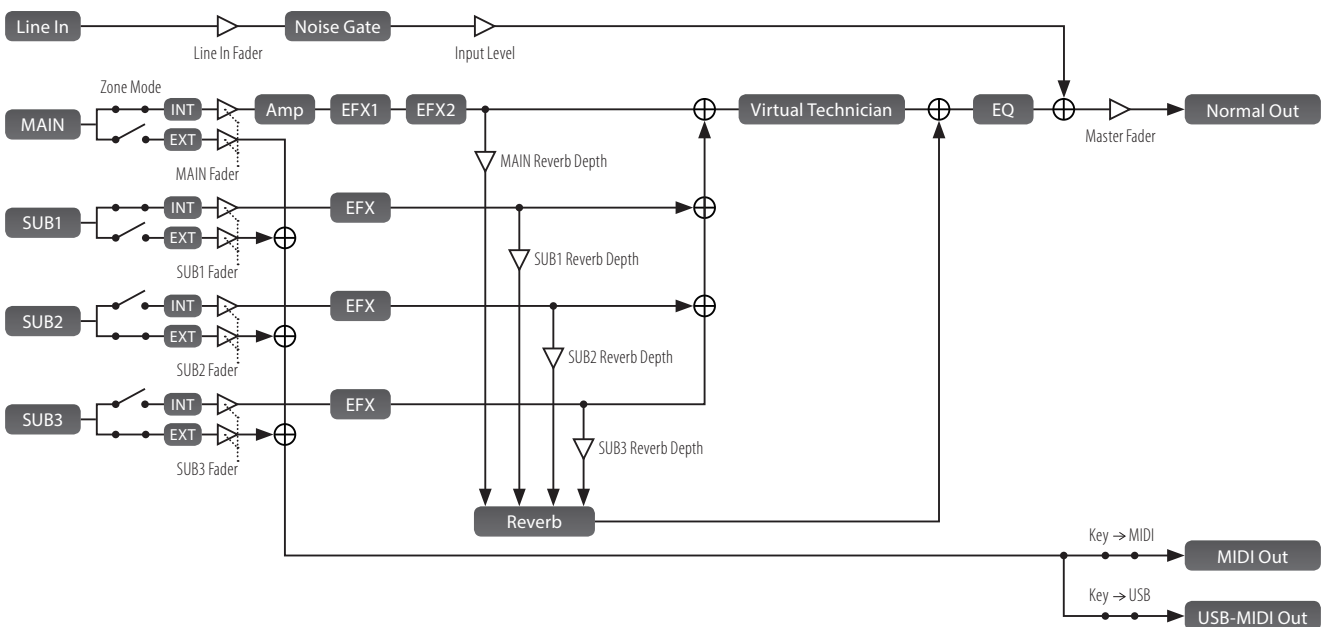

Getting Started

After connecting the power cable, speakers/headphones, and pedals, it's time to start playing the MP7SE stage piano. This page will explain how to turn on the instrument, set the MAIN zone volume, and adjust the master volume.

1. Turning the MP7SE ON

Press the POWER SWITCH.

The instrument will turn ON, and after a brief period the main Play Mode screen will be shown in the LCD display.

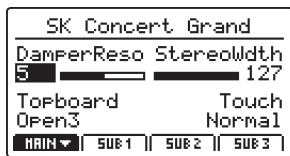
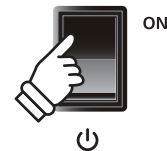

* For more information about the play screen, please refer to page 26.

* The MP7SE features a power saving mode that can turn off the instrument automatically after a specified period of inactivity. For more information, please refer to page 107.

2. Adjusting the MAIN zone volume

Move the MAIN zone volume fader to the top-most position.



* For more information about adjusting the volume of zones, please refer to page 22.

3. Adjusting the MP7SE's master volume

Move the MASTER VOLUME fader to the half-way position.

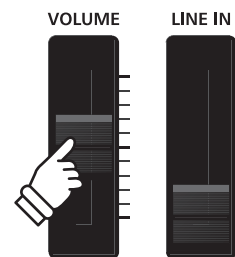

4. Playing the piano

Start playing the piano.

The rich sound of a Kawai SK-EX Concert Grand Piano will be heard as the keys are pressed.

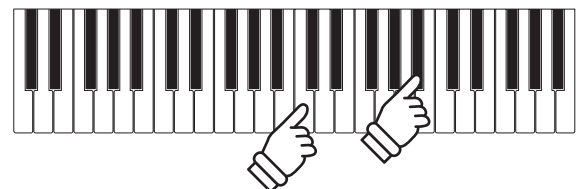

If necessary, increase or decrease the MASTER VOLUME fader to find a comfortable listening level.

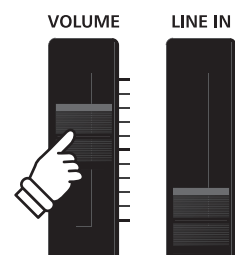

Selecting Sounds

The MP7SE stage piano features a wide selection of realistic instrument sounds suitable for various musical styles. Sounds are arranged into eight categories, with eight further sub-categories, and four variations, providing a total of 256 different instrument sounds. For a complete listing of the available instrument sounds, please refer to page 126 of this owner's manual.

* The example below will explain how to select the '60's EP 2' electric piano sound, however the process is identical for all other sounds.

1. Selecting the sound category

Press the desired sound category button from the top row of sound buttons.

The LED indicator for the button will turn ON to indicate that the category is selected, and a sound variation pop-up list will briefly be shown in the LCD display.

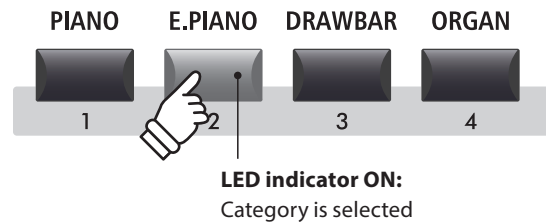

Example: To select the Electric Piano sound category, press the E.PIANO button.

2. Selecting the sound sub-category

Press the desired sound sub-category button from the middle row of sound buttons.

The LED indicator for the button will turn ON to indicate that the sub-category is selected, and a sound variation pop-up list will briefly be shown in the LCD display.

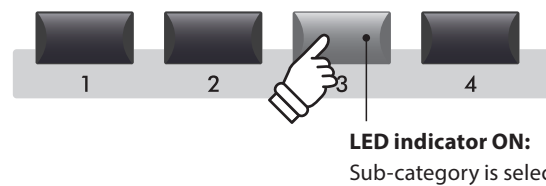

Example: To select the third sub-category of electric pianos, press the '3' sub-category button.

3. Selecting the sound variation

Press the desired sound variation button from the bottom row of sound buttons.

The LED indicator for the button will turn ON to indicate that the variation is selected, and a sound variation pop-up list will briefly be shown in the LCD display.

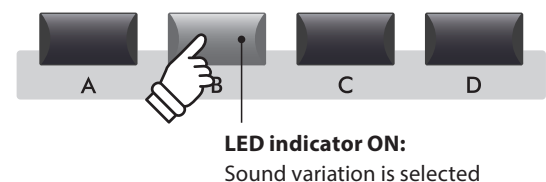

Example: To select the '60's EP 2' sound, press the 'B' sound variation button.

* Sounds can be selected by pressing the category, sub-category, and variation buttons in any order.

* When selecting a different sound category, the previously selected sub-category and variation will be recalled automatically.

Zone Functions

1 Zone Basics

As noted in the Introduction chapter, the MP7SE features four zones: MAIN, SUB1, SUB2, and SUB3. This page will explain the process for turning zones ON and OFF, adjusting zone volumes, and creating a simple two zone layer.

■ Turning a zone ON or OFF

Press the button corresponding to the desired zone to turn that zone ON or OFF.

The LED indicator for the pressed zone button will turn ON or OFF to indicate the current status of the zone.

If a zone is turned OFF but then selected, a * symbol will be added to the left of the sound name in the LCD display.

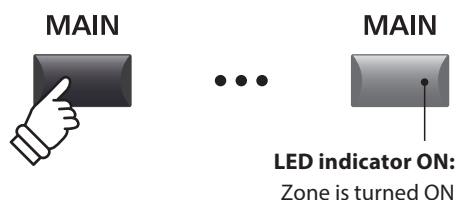

* When a zone is turned OFF, information for the previously selected (or neighbouring) zone will be shown in the LCD display.

* When Receive Mode (page 110) is set to 'Multi', the MIDI input signal will still trigger sounds even when a zone is turned OFF.

■ Adjusting the zone volume

Use the VOLUME fader above each zone button to adjust the volume of that zone.

The volume of the zone will increase or decrease independently of the other zones.

* When playing with just a single zone (e.g. MAIN), it is recommended to set the volume fader to the maximum position and use the MASTER volume fader to adjust the overall volume of the instrument.

To adjust the volume of all sound sections simultaneously, use the MASTER VOLUME fader (page 12).



* When tonewheel organ mode is selected and the sound edit screen shown in the LCD display, these VOLUME faders are used to adjust the drawbar positions of the organ. For more information please refer to page 32.

■ Creating a simple two zone layer

First, turn the MAIN zone ON, then select a piano sound.

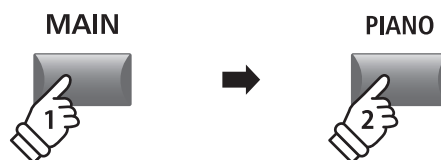

Next, turn the SUB1 zone ON, and select a strings sound.

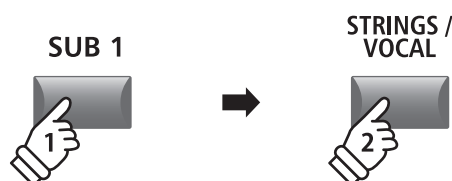

Play the layered piano and strings sound, adjusting the MAIN and SUB1 volume faders to set the level of each sound.

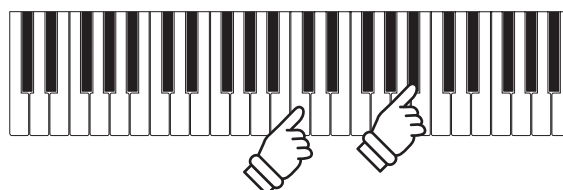

2 Zone Modes (INT/EXT/BOTH)

Also noted in the introduction, the MP7SE's four zones can each be set to control the instrument's internal sounds (INT), external MIDI devices (EXT), or both internal and external simultaneously (BOTH). This page will outline the differences between the zone modes, and explain how to switch between them.

Zone modes

Zone mode	Description	Panel Appearance
INT	The zone will control internal sounds only.	INT EXT ● ○
EXT	The zone will control external MIDI devices only.	INT EXT ○ ●
BOTH	The zone will control both internal sounds and external MIDI devices simultaneously.	INT EXT ● ●

Selecting zones

Press the F1~F4 function buttons located below the LCD display to select the desired zone.

The selected zone will be shown in the LCD display.

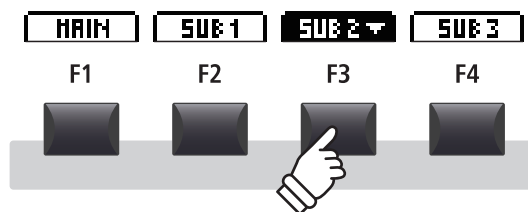
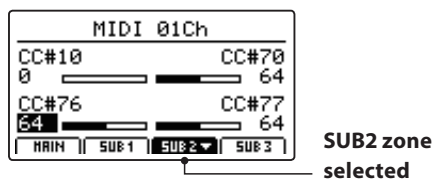

Example: To select the SUB2 zone, press the F3 function button.

Changing the zone mode

Press and hold the INT/MIDI button, then press the +/YES or -/NO buttons to cycle through the different zone modes.

The LED indicator for the zone will change to indicate the selected zone mode, and the Zone Mode pop-up will briefly be shown in the LCD display.

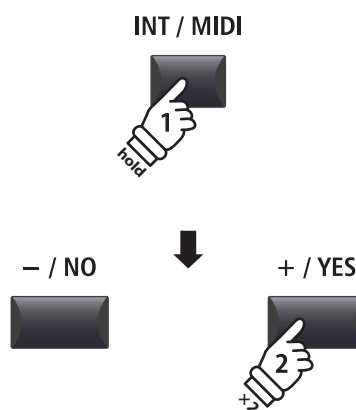
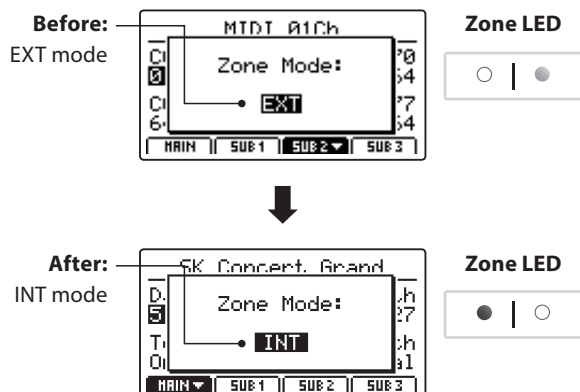

Example: To change the SUB2 zone from EXT mode to INT mode, press and hold the INT/MIDI button, then press the +/YES button twice.

* By default, the MAIN and SUB1 zones will be set to INT mode, and the SUB2 and SUB3 zones will be set to EXT mode.

3 Zone Key Range

By default, the four zones will each utilise all 88-key of the MP7SE's keyboard. However, by using the Key Range function it is possible to create custom keyboard ranges (between two defined keys) for each zone, allowing a selection of internal sounds or external MIDI devices to be controlled by different parts of the keyboard.

* The example below will explain how to specify key ranges for just the MAIN and SUB1 zones (with a piano sound and acoustic bass sound assigned to the two zones), however the process is identical for all four zones.

1. Selecting sounds for the MAIN and SUB1 zones

First, turn the MAIN zone ON, then select a piano sound.

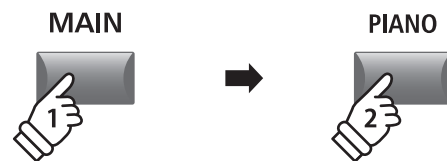
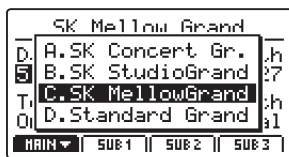

Next, turn the SUB1 zone ON, and select a bass sound.

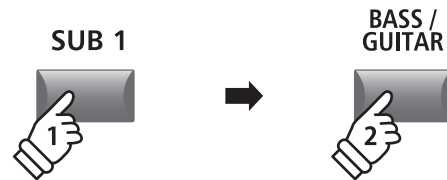

Play the piano.

The piano sound will be layered with the bass sound because both the MAIN and SUB1 zones are set to use the full keyboard.

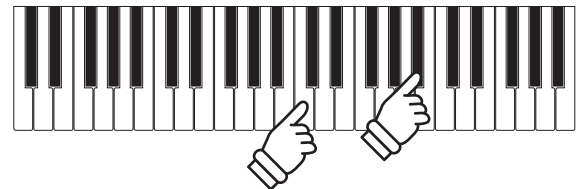

The next step is to specify key ranges for the two zones, allowing the piano and bass sounds to be played independently.

■ Checking the zone key range

Press and hold the MAIN button.

The current key range for the MAIN zone will be shown in the LCD display.



Next, press and hold the SUB1 button.

The current key range for the SUB1 zone will be shown in the LCD display.



2. Setting the MAIN zone key range

Press and hold the MAIN button, then press the desired low key, followed by the desired high key for the zone.

The names of the pressed low and high keys will be shown in the LCD display, and will become the new key range for the MAIN zone.

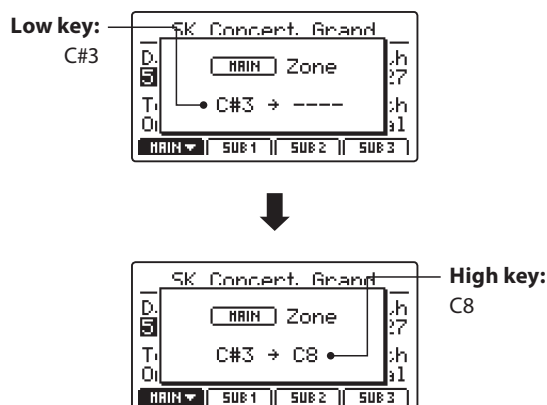

The LED indicator for the MAIN button will also turn green to indicate that a key range has been set.

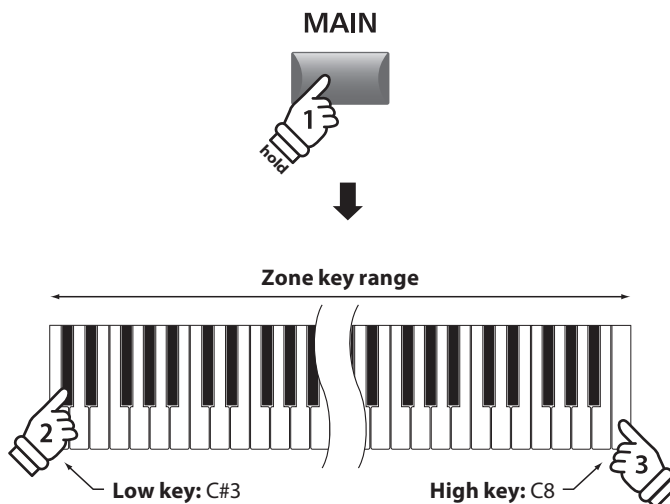

Example: To set the MAIN zone key range between key C#3 and C8, press and hold the MAIN zone button, then press the C#3 key, followed by the C8 key.

* It is also possible to set the zone key range using the KeySetup parameters in the EDIT menu. For more information, please refer to page 47.

3. Setting the SUB1 zone key range

Press and hold the SUB1 button, then press the desired low key, followed by the desired high key for the zone.

The names of the pressed low and high keys will be shown in the LCD display, and will become the new key range for the SUB1 zone.

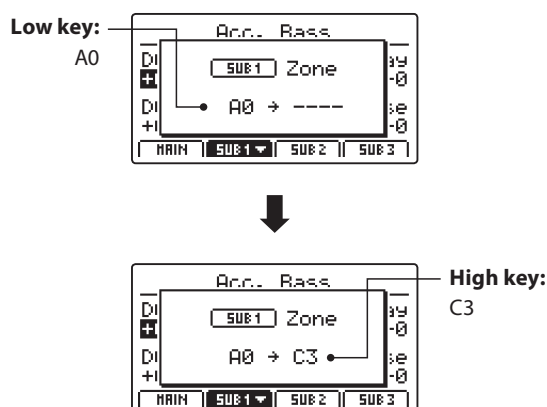

The LED indicator for the SUB1 button will also turn green to indicate that a key range has been set.

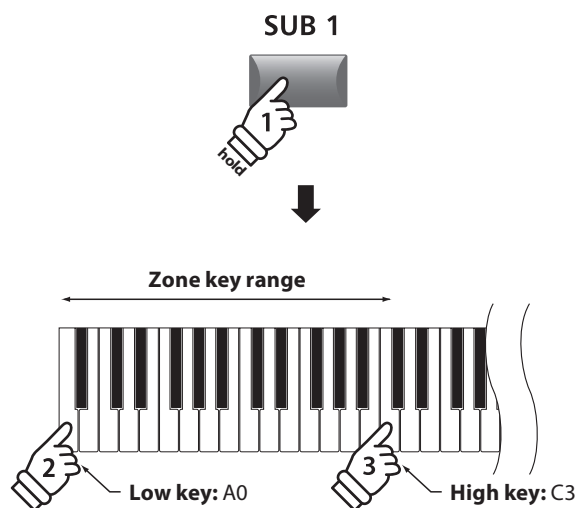

Example: To set the SUB1 zone key range between key A0 and C3, press and hold the SUB1 zone button, then press the A0 key, followed by the C3 key.

* It is also possible to set the zone key range using the KeySetup parameters in the EDIT menu. For more information, please refer to page 47.

4. Playing the MAIN and SUB1 zone key ranges

Test the new zone key ranges by playing a chromatic scale from the bottom-most note of the keyboard. The bass sound will be heard from the bottom-most key to the C3 key, and the piano sound will be heard from the C#3 key to the top-most key. This bass/piano configuration is a popular combination for playing jazz standards.

LCD Display & Control Knobs

In regular Play Mode the LCD display provides a visual indication of the selected zone and sound, and the values of the four real-time control knobs (A, B, C, and D).

The function of each knob can be assigned to control any parameter in the EDIT menu, allowing frequently used functions to be accessed from a single screen. Furthermore, two groups of knob parameters (2 x 4) can be defined for each of the MAIN, SUB1, SUB2, and SUB3 zones, providing extensive real-time control.

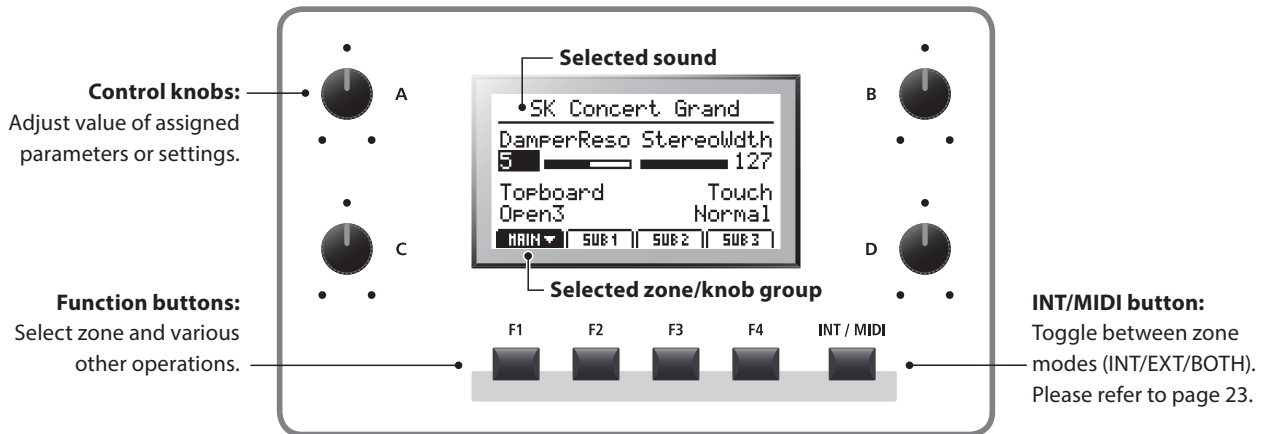

■ Selecting zones, primary/secondary knob groups

Press the F1~F4 function buttons located below the LCD display to select the desired zone.

The bottom tab representing the zone will become highlighted, and the name of the selected sound and primary group of knob parameters will be shown in the LCD display.

Press the same function button to cycle between the zones' primary and secondary knob parameters in the LCD display.

* While in the EDIT menu, pressing the same F1~F4 FUNCTION button will scroll through the different parameter pages.

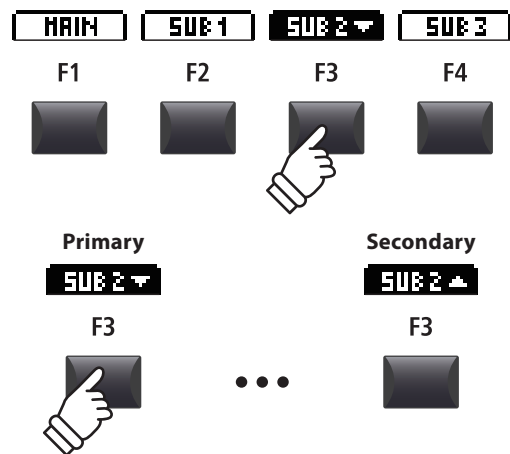

■ Changing zones modes (INT/MIDI button)

For information about changing zone modes, please refer to page 23.

■ Adjusting parameters

Turn the four control knobs (A, B, C, D) located on either side of the LCD display to adjust the displayed knob group parameters.

* EDIT menu parameters can be freely assigned to each of the four knobs in the Knob Assign page of the EDIT menu (page 51).

Parameters can also be adjusted by using the CURSOR buttons to move the selection cursor, and +/YES or -/NO buttons to increase or decrease the value of the selected parameter.

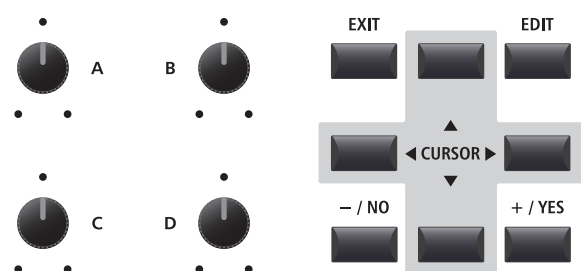

1 Reverb

Reverb adds reverberation to the sound, simulating the acoustic environment of a recital room, stage, or concert hall. The MP7SE offers 6 types of high quality reverb, with independent ON/OFF and depth controls for each zone. The reverb type, pre-delay, and time parameters, however, are common for all zones.

* For more information about common parameters, please refer to page 38.

■ Reverb types

Reverb type	Description
Room	Simulates the ambience of a small rehearsal room.
Lounge	Simulates the ambience of a piano lounge.
Small Hall	Simulates the ambience of a small hall.
Concert Hall	Simulates the ambience of a concert hall or theater.
Live Hall	Simulates the ambience of a live hall or stage.
Cathedral	Simulates the ambience of a large cathedral.

■ Turning reverb ON or OFF

Press the REVERB button for the desired zone to turn reverb for that zone ON or OFF.

The LED indicator for the zone's REVERB button will turn ON or OFF to indicate the current status of the reverb.

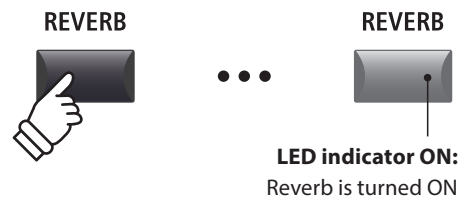

■ Changing the reverb type and additional parameters

Press and hold the REVERB button for the desired zone.

The REVERB page of the zone's EDIT menu will be shown in the LCD display.

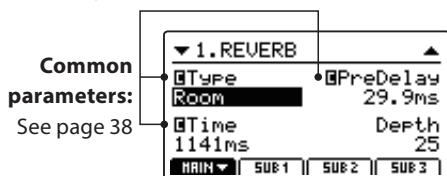

Turn the four control knobs (A, B, C, D) to change the reverb type and adjust additional reverb parameters.

Press and hold the REVERB button again to exit.

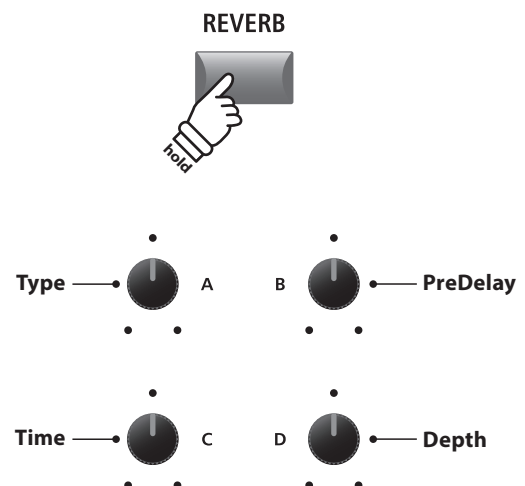

■ Reverb parameters

Knob	Parameter	Description	Value range
A	Type	Changes the type of environment.	(see table above)
B	PreDelay	Adjusts the delay time before the reverberation is applied.	0 ~ 200 ms
C	Time	Adjusts the decay length/speed of the reverberation.	300 ms ~ 10.0 s (depending on type)
D	Depth	Adjusts the depth of the environment (amount of reverberation).	0 ~ 127

2 EFX

In addition to reverb, various other effects can be applied to each zone, altering the tonal character and feeling of the selected sound. The MP7SE features 129 high quality EFX types, with effects automatically applied to some sounds by default in order to enhance their realism.

As noted in the introduction chapter, the MAIN and SUB1/SUB2/SUB3 zones share largely the same EFX operation, however there are some important specification and capability differences between the two zone types.

■ EFX specifications: MAIN and SUB1/SUB2/SUB3 zones

	MAIN zone	SUB1/SUB2/SUB3 zones
No. of EFX blocks	2 (applied in serial, independently adjustable)	1 each (independently adjustable)
No. of available effects	129 types	22 types
Amp Simulator	Yes	No

■ Available effect types: MAIN vs SUB1/SUB2/SUB3 zones

EFX category	M	S	EFX category	M	S	EFX category	M	S	EFX category	M	S
1 Chorus	8	2	7 Delay/Rev	8	2	13 Groove	4	1	19 Enhancer+	8	-
2 Flanger	5	2	8 PitchShift	3	1	14 Misc.	2	-	20 P.Shift+	6	-
3 Phaser	6	1	9 Compressor	2	1	15 Chorus+	6	-	21 Comp+	8	-
4 Wah	6	3	10 OverDrive	3	2	16 Phaser+	6	-	22 OverDrive+	8	-
5 Tremolo	6	3	11 EQ/Filter	5	2	17 Wah+	6	-	23 Parallel	6	-
6 AutoPan	4	1	12 Rotary	5	1	18 EQ+	8	-	TOTAL	129	22

* The '+' effects consist of the base effect plus an additional combination effect, while still using only one effect module.

* For more information about available effect categories, types, and parameters, please refer to page 128.

■ Turning effects ON or OFF

Press the EFX button for the desired zone to turn effects for that zone ON or OFF.

The LED indicator for the zone's EFX button will turn ON or OFF to indicate the current status of the effects.

* The MAIN zone's EFX1 and EFX2 modules and SUB1/SUB2/SUB3 zones' EFX modules are turned ON and OFF in exactly the same way.

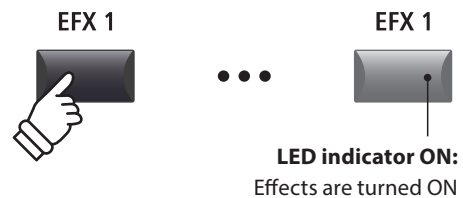

■ Changing the effect category, type and additional parameters

Press and hold the EFX button for the desired zone.

The first EFX page of the zone's EDIT menu will be shown in the LCD display.

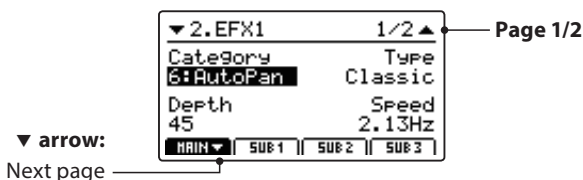

Turn the control knobs (A, B, C, D) to change the effect category, type, and adjust additional effect parameters.

- * The number of adjustable EFX parameters will vary depending on type. For more information, please refer to page 128.
- * Press the F1~F4 FUNCTION buttons (corresponding to the selected zone) to scroll through the different parameter pages.

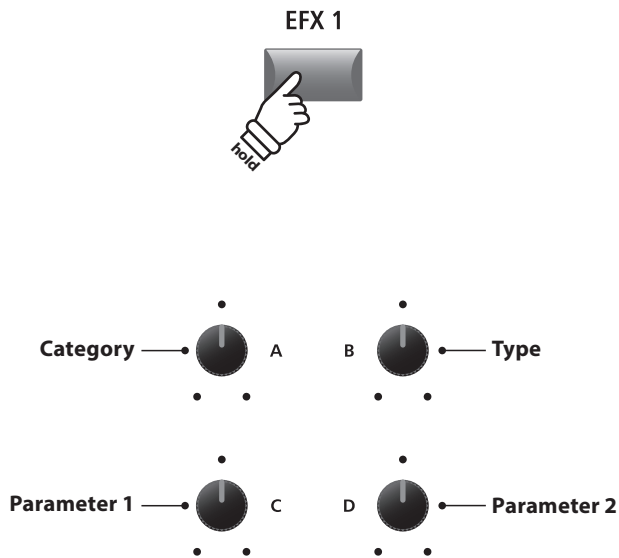

* Above knob assignments will change depending on EFX page displayed.

Press and hold the EFX button again to jump to the first EFX page of the EDIT menu, and once again to EXIT.

■ Eff.SW Mode parameter (SYSTEM menu)

The Eff.SW Mode parameter in the SYSTEM:Utility menu defines the extent to which EFX and other settings change when selecting sounds. When this parameter is set to 'Fixed' mode, it is possible to copy the same EFX settings to multiple sounds.

* For more information about the Eff.SW Mode parameter, please refer to page 106.

■ About Substitute effects for SUB1/SUB2/SUB3 zones

As noted above, the total number of effect types available for the MAIN zone is much larger than that of the SUB zones. Therefore, when assigning a sound to a SUB zone that was prepared using an effect only available for the MAIN zone, the MP7SE will automatically select the closest 'substitute' effect. An  icon will also be shown beside the type parameter to indicate that a substitute effect is being used.

The example below shows the 'Classic' AutoPan effect being substituted for the 'Standard' AutoPan effect.

* Only the EFX1 effect will be substituted. Any effects that are assigned to EFX2 will be disregarded.

MAIN zone EFX1 screen

A sound prepared on the MAIN zone with 'Classic' AutoPan effect applied.

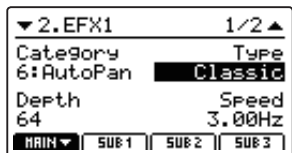

Substitute effect icon

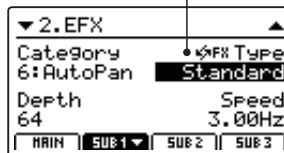

SUB1 zone EFX screen

The same sound assigned to SUB1 zone, 'Standard' AutoPan effect is automatically substituted.

3 Amp Simulator (MAIN zone only)

The tonal character of an amplifier or speaker cabinet is an important component of vintage electric piano sounds. The MP7SE's Amp Simulator function features 5 typical amplifier types and a selection of adjustable parameters.

Amp types

Amp type	Description
S. Case	A suitcase type amplifier, commonly used for vintage electric piano sounds.
M. Stack	A British valve guitar amplifier, known for its 'crunchy' tonal character.
J. Combo	A popular Japanese solid-state amplifier favoured for its clean, yet powerful sound.
F. Bass	An American valve bass amplifier that became popular for guitar, harmonica, and other instruments.
L. Cabi	A valve amplifier and speaker enclosed within a wooden cabinet, originally intended for drawbar organ sounds, but also used with electric pianos to produce a distinctive 'shimmering' sound.

Turning the Amp Simulator ON or OFF

Press the MAIN zone's AMP button to turn the amp simulator ON or OFF.

The LED indicator for the AMP button will turn ON or OFF to indicate the current status of the amp simulator.

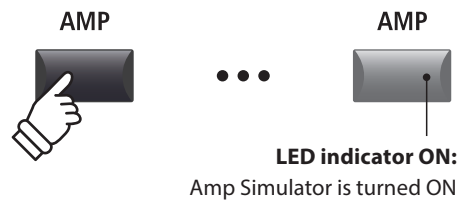

Changing the Amp type, adjusting drive, and level parameters

Press and hold the MAIN zone's AMP button.

The first AMP page of the EDIT menu will be shown in the LCD display.

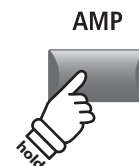
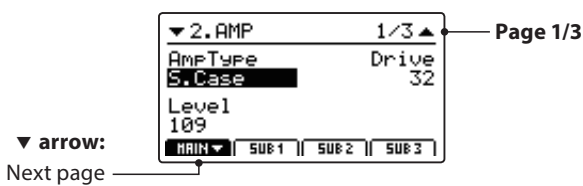

Turn the control knobs (A, B, C) to change the amp type, and adjust the drive and level parameters.

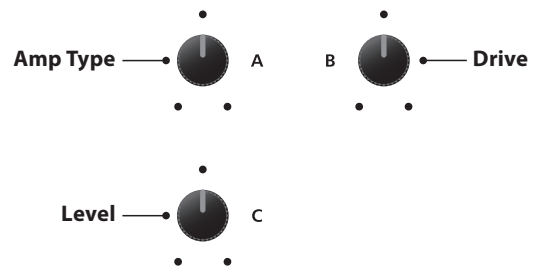

* For more information about additional Amp Simulator parameters, please refer to page 41.

* Press the F1 FUNCTION buttons (corresponding to the MAIN zone) to scroll through the different AMP parameter pages.

Press and hold the AMP button again to jump to the first AMP page of the EDIT menu, and once again to EXIT.

* Above knob assignments will change depending on AMP page displayed.

■ Amp Simulator parameters

Page	Knob	Parameter	Description	Value range
1	A	Amp Type	Changes the type of amplifier model.	[see table above]
	B	Drive	Adjusts the drive level of the amplifier.	0 ~ 127
	C	Level	Adjusts the overall volume level of the amplifier.	0 ~ 127
2	A	Amp EQ Lo	Adjusts the gain of the amplifier's low frequencies.	-10 dB ~ +10 dB
	B	Amp EQ Mid	Adjusts the gain of the amplifier's mid frequencies.	-10 dB ~ +10 dB
	C	Amp EQ Hi	Adjusts the gain of the amplifier's high frequencies.	-10 dB ~ +10 dB
	D	Mid Frequency	Adjusts the frequency of the amplifier's mid-range band.	200 Hz ~ 3150 Hz
3	A	Mic Type	Changes the type of microphone used for the amplifier.	Condenser, Dynamic
	B	Mic Position	Change the position of the microphone used for the amplifier.	OnAxis, OffAxis
	C	Ambience	Adjusts the mixing ratio of additional ambient microphones.	0 ~ 127

■ Adjusting additional Amp Simulator parameters

Press and hold the MAIN zone's AMP button, then press the F1 FUNCTION button (corresponding to the selected MAIN zone).

The second AMP page of the EDIT menu will be shown in the LCD display.

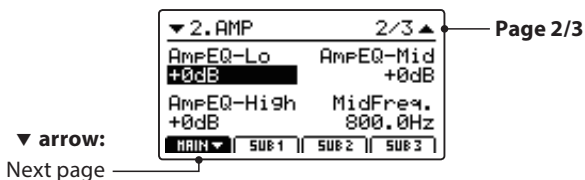

Turn the control knobs (A, B, C, D) to adjust the amp simulator's Lo, Mid, Hi, and MidFreq EQ parameters.

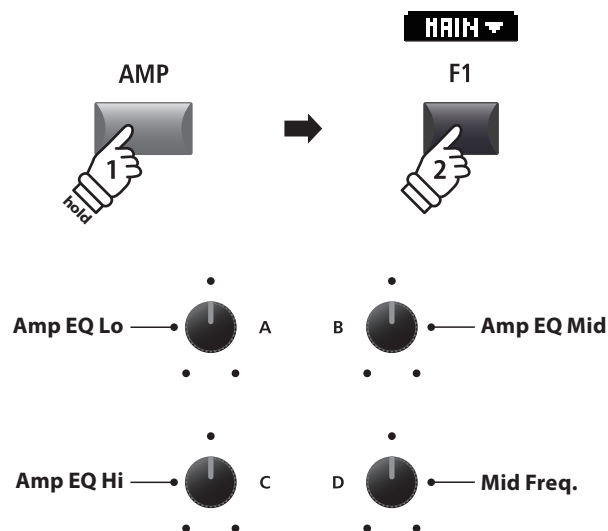

Press the F1 button again.

The third AMP page of the EDIT menu will be shown in the LCD display.

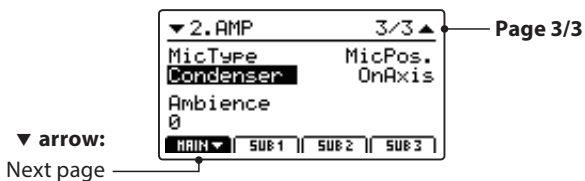

Turn the control knobs (A, B, C) to change the type and positioning of the amp simulator's microphone, and adjust the ambience parameter.

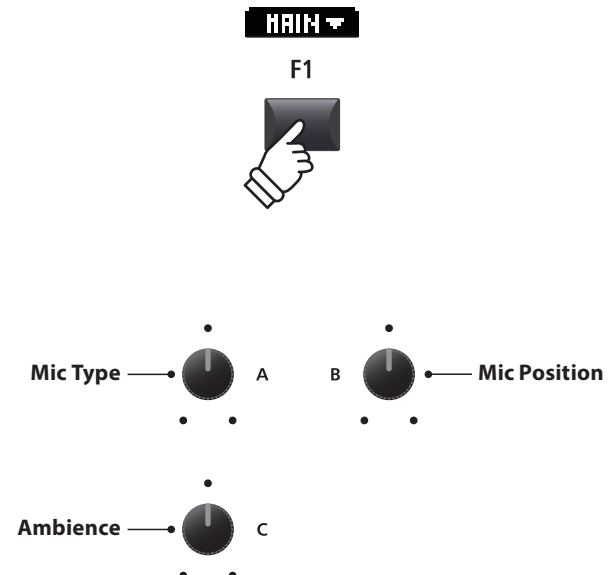

Tonewheel Organ Mode

The MP7SE's tonewheel mode is a special function that transforms the instrument into a vintage electromechanical organ, complete with drawbar, percussion, and slow/fast rotary speaker controls. Tonewheel mode is only available for the MAIN zone, and activated when selecting the DRAWBAR sound category and 1, 2, or 3 sub-categories.

Upon activating tonewheel mode and selecting the tonewheel edit screen, the MP7SE's zone faders will act as virtual organ drawbars, with the MAIN, SUB1, SUB2, and SUB3 zone buttons also used to change percussion functions.

1. Activating tonewheel organ mode

After selecting the MAIN zone:

Press the DRAWBAR sound category button, then press either the 1, 2, or 3 sub-category buttons.

The LED indicators for the pressed buttons will turn ON, and the selected tonewheel sound will be shown in the LCD display.

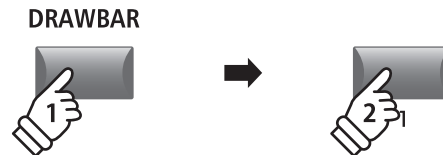

* The tonewheel mode can only be selected for the MAIN zone. When a SUB zone is selected and the DRAWBAR 1/2/3 buttons are pressed, a pop-up reminder will be shown and the selected sound will remain unchanged.

2. Showing the tonewheel edit screen

Press the SW2 button.

The LED indicator for the SW2 button will turn on and the tonewheel edit screen will be shown in the LCD display.

* The tonewheel edit screen can also be shown by selecting the Sound page of the EDIT menu when tonewheel mode is activated.

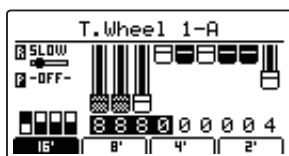
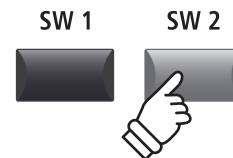

* If the assigned function of the SW2 button is changed from the default 'TW Control', the tonewheel edit screen will not be shown.

* For information about changing the assigned SW1/SW2 function, please refer to page 49.

Tonewheel edit screen

Selected tonewheel sound:
Stored to DRAWBAR sounds 1-3, A-D.

Rotary speed:
Indicates slow or fast rotary. Toggled by the SW1 button or FSW pedal.

Percussion setting:
Adds percussive 'attack' to the organ sound. Adjusted using the zone buttons.

Selected drawbar group:
Indicates which drawbars will be adjusted using the zone faders and control knobs.

Drawbar registration:
Visual representation of the organ's drawbar positions. Adjusted using the zone faders and control knobs.

* The tonewheel organ drawbars can also be adjusted via MIDI. For more information, please refer to page 44.

■ Adjusting the organ's drawbar registration

While the tonewheel edit screen is shown in the LCD display, and the 16' drawbar group tab is selected:

Use the zone faders to adjust the position of the first four organ drawbars.

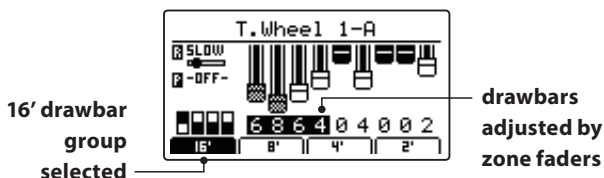

Turn the control knobs (A, B, C, D) to adjust the position of the next four organ drawbars.

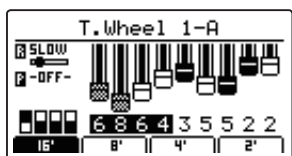

Finally, press the +/YES or -/NO buttons to adjust the position of the last organ drawbar.

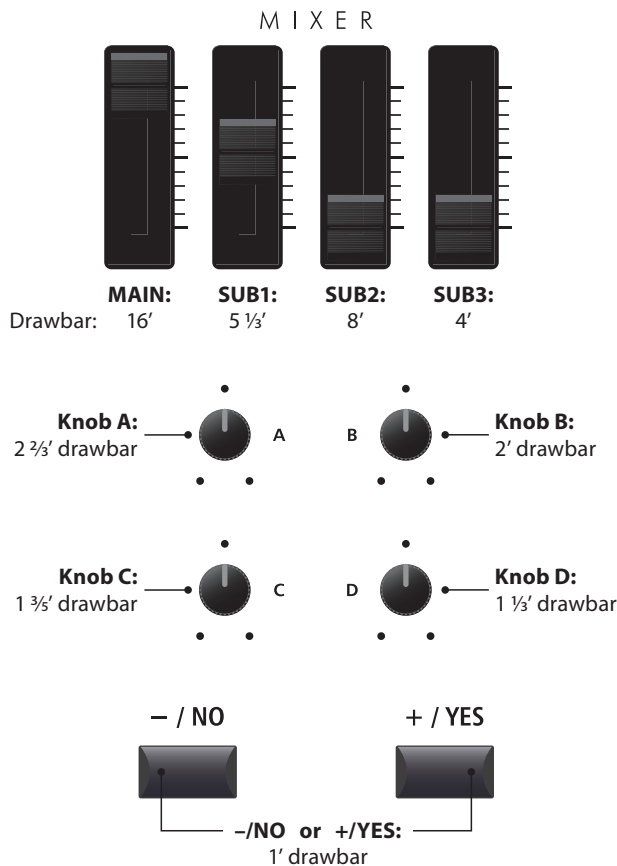
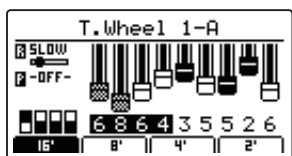

■ Changing the selected drawbar group

Press the F1~F4 function buttons to select which four drawbars are adjusted by the zone faders.

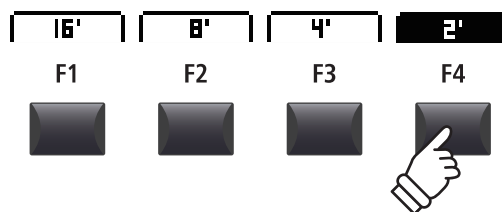
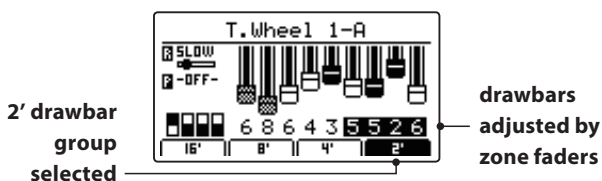

* The control knob and -/NO and +/YES button drawbar assignments will change depending on the selected zone faders.

■ Changing organ percussion settings and rotary effect speed

While the tonewheel edit screen is shown in the LCD display:

Press the MAIN button to turn percussion ON or OFF, and the SUB buttons to adjust the percussion characteristics.

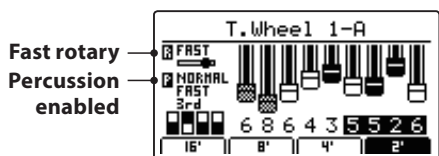

Press the SW1 button or FSW pedal to change the speed of the rotary effect from slow to fast.

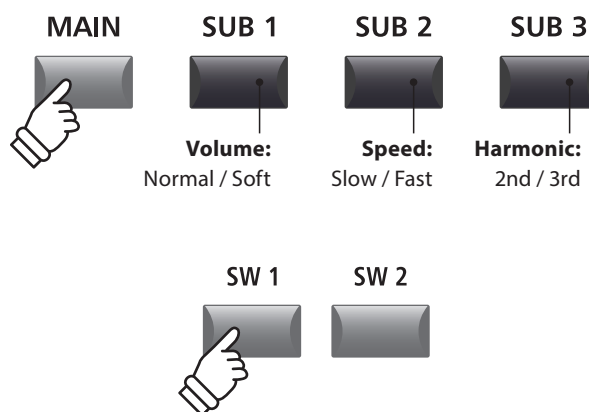

1 EQ

The EQ function consists of a 4-band graphic equaliser that can be used to shape the overall tone of the MP7SE's internal sounds. Two of the mid-range frequency bands can also be adjusted as a parametric equaliser.

The equaliser settings are common for all zones.

* For more information about common parameters, please refer to page 38.

■ Turning EQ ON or OFF

Press the EQ button to turn the MP7SE's equaliser ON or OFF.

The LED indicator for the EQ button will turn ON or OFF to indicate the current status of the equaliser.



■ EQ parameters

Page	Knob	Parameter	Description	Value range
1	A	Low Gain	Adjusts the gain of the low range frequency band (20 ~ 100 Hz).	-10 dB ~ +10 dB
	B	High Gain	Adjusts the gain of the high range frequency band (5000 ~ 20000 Hz).	-10 dB ~ +10 dB
	C	Mid1 Gain	Adjusts the gain of the Mid1 frequency band (200 ~ 3150 Hz).	-10 dB ~ +10 dB
	D	Mid2 Gain	Adjusts the gain of the Mid2 frequency band (200 ~ 3150 Hz).	-10 dB ~ +10 dB
2	A	Mid1 Q	Adjusts the bandwidth of the Mid1 band.	0.5 ~ 4.0
	B	Mid2 Q	Adjusts the bandwidth of the Mid2 band.	0.5 ~ 4.0
	C	Mid1 Freq.	Adjusts the frequency of the Mid1 band.	200 Hz ~ 3150 Hz
	D	Mid2 Freq.	Adjusts the frequency of the Mid2 band.	200 Hz ~ 3150 Hz

■ Adjusting EQ parameters

Press and hold the EQ button.

The gain page of the EQ will be shown in the LCD display.

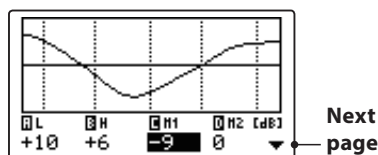

Press the CURSOR ◀▶ buttons to select the desired EQ parameter, then press the +/YES or -/NO buttons to increase or decrease the values.

Alternatively, turn the control knobs (A, B, C, D) to adjust the EQ parameter assigned to that knob.

* The F1~F4 buttons can also be used to select the desired EQ parameter. If the parameter is already selected, the F1~F4 buttons can be used to alternate between the gain and frequency pages of the EQ.

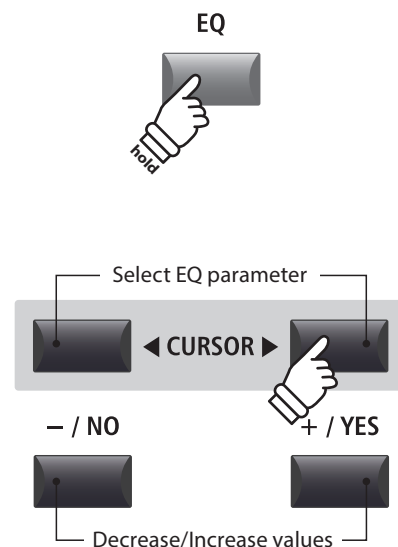

■ Adjusting EQ parameters (cont.)

While the gain page of the EQ is shown:

Press the CURSOR ▼ button.

The frequency page of the EQ will be shown in the LCD display.

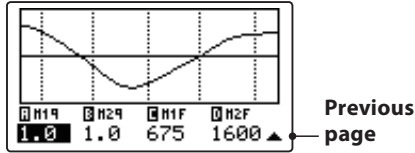

Press the CURSOR ◀▶ buttons to select the desired EQ parameter, then press the +/YES or -/NO buttons to increase or decrease the values.

Alternatively, turn the control knobs (A, B, C, D) to adjust the EQ parameter assigned to that knob.

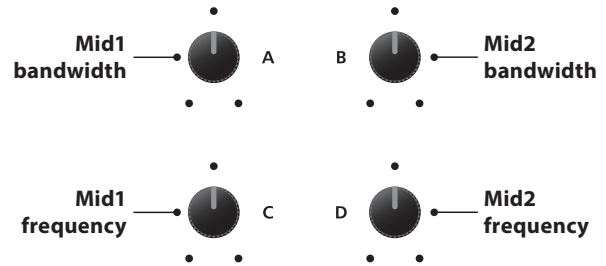

Press the EXIT button to return to the main playing screen.



■ Jump to EQ Offset shortcut

The EQ Offset is a SYSTEM parameter used to offset adjustments made by the EQ. The purpose of the EQ Offset is to allow a 'baseline' EQ to be applied independently of the EQ function, and therefore independently of the selected SETUP. EQ Offset must be enabled in the SYSTEM menu for this shortcut to function.

* For more information about the EQ Offset function, please refer to page 111.

To jump to the EQ Offset screen, at any time:

Press and hold the EQ button, then press one of the F1~F4 buttons.

The EQ Offset screen will be shown in the LCD display.

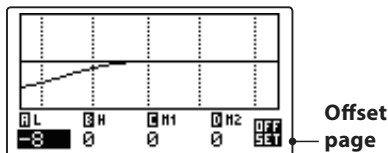

The EQ Offset parameters are adjustable in the same manner as the EQ gain parameters.

* The EQ Offset values will be added to the regular EQ values. The combined EQ values are limited to ± 10 dB.

Press the EXIT button to return to the EQ screen.
Press the EXIT button again to return to the main playing screen.

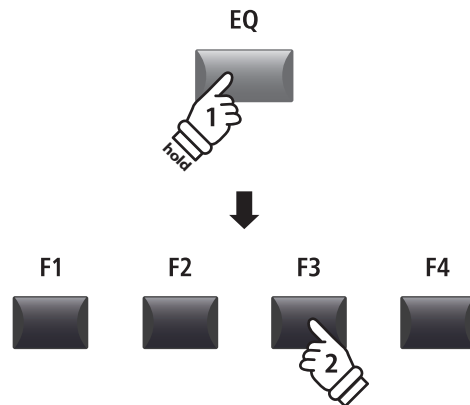

2 Transpose

The Transpose function allows the pitch of the MP7SE's keyboard to be raised or lowered in semi-tone steps. This is particularly useful when accompanying instruments tuned for different keys, or when a song learned in one key must be played in another key.

Setting the Transpose value: Method 1

Press and hold the TRANSPOSE button, then press the +/YES or -/NO buttons to increase or decrease the transpose value in semi-tone steps.

* The TRANSPOSE value can be adjusted within the range of -24 ~ +24.

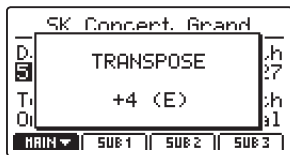

The LED indicator for the TRANSPOSE button will turn ON automatically to indicate that transpose is activated.

* To reset the transpose value to 0 (no transposition), press both the -/NO and +/YES buttons simultaneously. The LED indicator for the TRANSPOSE button will turn off automatically.

* The transpose value will be stored to SYSTEM memory automatically, however the transpose ON/OFF state will not be stored.

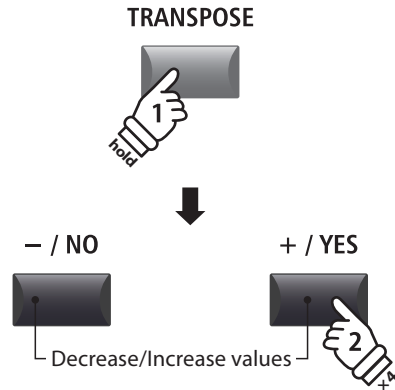

Example: To raise the keyboard pitch by 4 semi-tones, press and hold the TRANSPOSE button, then press the +/YES button four times.

Setting the Transpose value: Method 2

Press and hold the TRANSPOSE button, then press a key on the keyboard to the left or right of middle C.

The pressed key will become the new transpose key.

* The TRANSPOSE value can be adjusted within the range of -24 ~ +24.

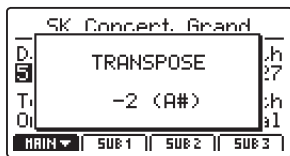

The LED indicator for the TRANSPOSE button will turn ON automatically to indicate that transpose is activated.

* To reset the transpose value to 0 (no transposition), press both the -/NO and +/YES buttons simultaneously. The LED indicator for the TRANSPOSE button will turn off automatically.

* The transpose value will be stored to SYSTEM memory automatically, however the transpose ON/OFF state will not be stored.

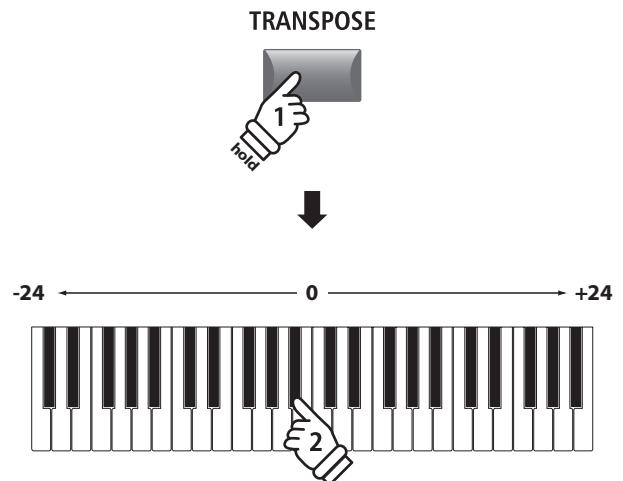

Example: To lower the keyboard pitch by 2 semi-tones, press and hold the TRANSPOSE button, then press the B^b key closest to the middle C key.

■ Turning Transpose ON or OFF

Press the TRANSPOSE button to turn the transpose function ON or OFF.

The LED indicator for the TRANSPOSE button will turn ON or OFF to indicate the current status of the transpose function.

* The previous transpose setting will be remembered after the transpose function is turned OFF, allowing rapid adjustment of the keyboard pitch.

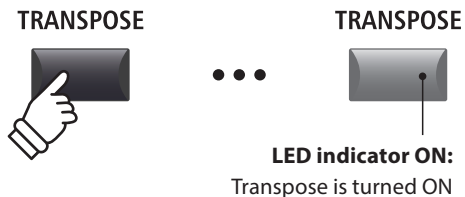

■ Checking the Transpose setting

Press and hold the TRANSPOSE button.

The current transpose setting will pop-up in the LCD display.

* The default value, 0, indicates no transposition.

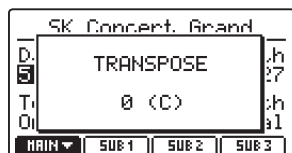
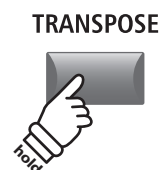

3 Local Off

The Local Off function allows the connection between the MP7SE's keyboard and tone generator to be disabled. This may be useful when using the MP7SE to control an external MIDI device, without the keyboard triggering the instrument's internal sounds.

■ Local function

LOCAL OFF button LED	Description
OFF (default)	The MP7SE will transmit information to external MIDI devices, and play internal sounds.
ON	The MP7SE will transmit information to external MIDI devices only, and not play internal sounds.

■ Turning the Local function ON or OFF

Press the LOCAL OFF button.

The LED indicator for the LOCAL OFF button will turn ON or OFF to indicate the current status of the Local function.

The Local status pop-up will briefly be shown in the LCD display.

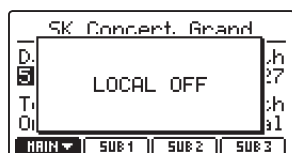
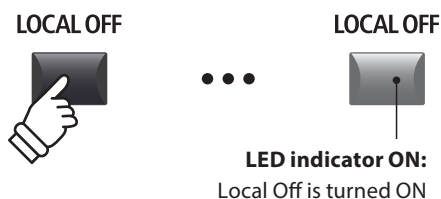

Overview of the EDIT Menu (INT mode)

The EDIT menu contains various parameters that can be used to adjust the MP7SE's MAIN and SUB zones in INT mode. The parameters are grouped by category, allowing close control over the instrument with just a few button presses.

* The EDIT menu can also be used to adjust the parameters of zones in EXT mode. For more information, please refer to page 54.

This collection of parameters, together with other adjustable settings, can be stored as a SETUP memory (page 65). The MP7SE provides 256 user programmable SETUP memories.

About Common parameters (🔑 icon)

Unless stated, parameter settings for the MAIN, SUB1, SUB2, and SUB3 zones are independent for each zone. However, parameters marked with a 🔑 icon are common for all four zones. For example, changing the 🔑Reverb Type parameter for the MAIN zone will automatically change the 🔑Reverb Type parameter for the SUB1, SUB2, and SUB3 zones.

INT mode zone parameters

No.	Category	Parameters
1	REVERB	🔑Type, 🔑Pre Delay, 🔑Time, Depth
2	EFX	Category, Type, Parameters (prm1~prm10, depending on EFX type)
	AMP	Amp Type, Drive, Level, Amp EQ Lo, Amp EQ Mid, Amp EQ Hi, Mid Freq., Mic Type, Mic Position, Ambience
3	Sound	🔑Master Volume, Panpot, Filter Cut-off, Filter Resonance, DCA Attack Time, DCA Decay Time, DCA Sustain Level, DCA Release Time, DCF Attack Time, DCF Attack Level, DCF Decay Time, DCF Sustain Level, DCF Release Time, DCF Touch Depth, DCA Touch Depth, Vibrate Depth, Vibrate Rate, Vibrate Delay, Octave Layer Switch, Octave Layer Level, Octave Layer Range, Octave Layer Detune, Portamento, Porta. Time, Porta. Mode TONEWHEEL: Drawbar Position, Percussion, Perc. Level, Perc. Decay, Perc. Harmonic, 🎛️ Ext. Control
4	Tuning	Fine Tune, Stretch Tuning, Temperament, Key of Temperament
5	Key Setup	Touch Curve, Dynamics, Trigger Mode, Minimum Touch, Octave Shift, Zone Transpose, Key Scaling Damping, Key Scaling Key, Key Range Zone Lo, Key Range Zone Hi, Velocity Switch, Velocity Switch Value, Solo, Solo Mode, Key Volume
6	Controllers	Damper Pedal, 🔑Damper Pedal Assign, Damper Pedal Mode, Pitch Bend, P. Bend Range, Soft Pedal Depth, Modulation Wheel, Modulation Wheel Assign, Modulation Depth Range, SW1 Button, 🔑SW1 Button Assign, SW2 Button, 🔑SW2 Button Assign, Footswitch Pedal, 🔑Footswitch Pedal Assign, Expression Pedal, 🔑Expression Pedal Assign, Right Pedal, 🔑Right Pedal Assign, Center Pedal, 🔑Center Pedal Assign, Left Pedal, 🔑Left Pedal Assign
7	Knob Assign	Knob A Assign, Knob B Assign, Knob C Assign, Knob D Assign, Knob2 A Assign, Knob2 B Assign, Knob2 C Assign, Knob2 D Assign
8	Virtual Technician	PIANO: Voicing, String Resonance, Undamped Resonance, Damper Resonance, Key-off Effect, Damper Noise, Hammer Delay, Fall-back Noise, Topboard, Stereo Width E.PIANO/HARPSI/BASS: Key-off Noise, Key-off Delay DRAWBAR: Key Click Level, Wheel Noise Level

Entering the EDIT Menu

When the zone is in INT mode:

Press the EDIT button.

The LED indicator for the EDIT button will turn ON, and the Edit Menu for the selected zone will be shown in the LCD display.

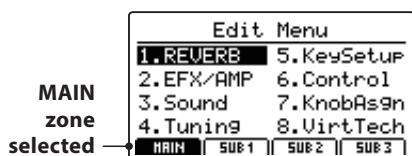

* To change the selected zone, press the F1~F4 function buttons.

■ Selecting the parameter category

After entering the EDIT Menu:

Press the CURSOR buttons to select the desired category, then press the +/YES button to enter the selected category.

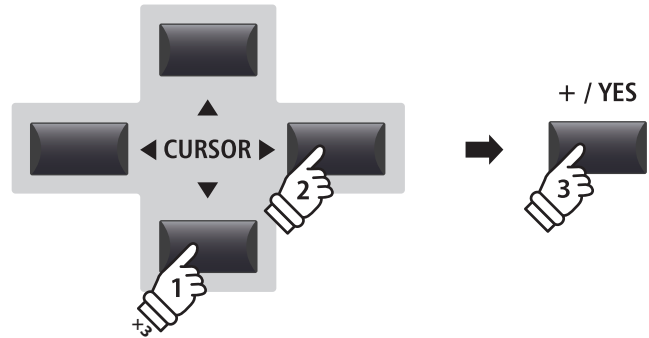

Example: To enter the Virtual Technician category, press the CURSOR▼ button three times and the CURSOR▶ button once, then press the +/YES button.

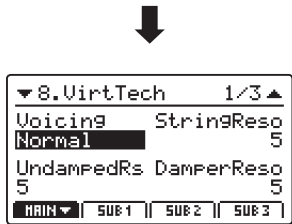

■ Adjusting parameters

After selecting the parameter category:

Turn the four control knobs (A, B, C, D) to adjust the parameters assigned to those knob.

Parameters can also be adjusted by using the CURSOR buttons to move the selection cursor, and +/YES or -/NO buttons to increase or decrease the value of the selected parameter.

Press the EXIT button to exit the parameter category, or return to the Play Mode screen.

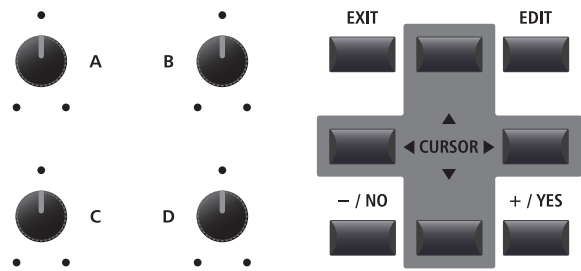

⚠ Parameter adjustments made to the selected sound will be lost upon selecting another sound.
 * To store the adjusted sound, use the STORE button (page 64).

■ Quick Compare function

The Quick Compare function allows any sound being adjusted to be compared 'on the fly' with the previously stored (i.e. preset) sound.

While in EDIT mode:

Press the variation button of the sound that is being adjusted.

The LED for the variation button will start to flash, and the keyboard will play the previously stored sound.

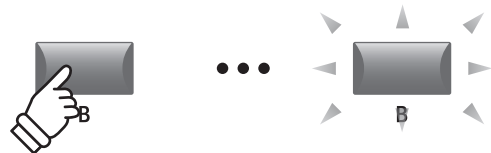
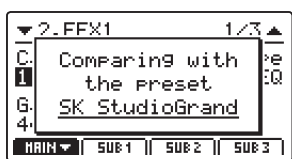

Example: To compare the adjusted SK Studio Grand sound with the previously stored version, press the 'B' sound variation button.

Press the variation button again.

The LED for the variation button will stop flashing, turn ON, and the keyboard will return to playing the adjusted sound.

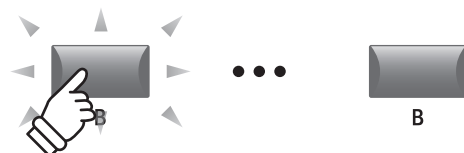

EDIT Menu parameters (INT mode)

1 Reverb

1. **Type**

6 TYPES

This parameter selects the reverb type.

* For more information about reverb, please refer to page 27.

* This parameter is common for all four zones.

* This parameter is not stored to SOUND but to SETUP only.

2. **Pre Delay**

VALUE: 0 ~ 200 MS

This parameter adjusts the delay time before the start of the reverberation.

* For more information about reverb, please refer to page 27.

* This parameter is common for all four zones.

* This parameter is not stored to SOUND but to SETUP only.

3. **Time**

VALUE: 300 MS ~ 10.0 S

This parameter adjusts the reverb time.

* For more information about reverb, please refer to page 27.

* This parameter is common for all four zones.

* This parameter is not stored to SOUND but to SETUP only.

4. **Depth**

VALUE: 0 ~ 127

This parameter adjusts the reverb depth.

* For more information about reverb, please refer to page 27.

2.1 EFX

1. **Category**

23 CATEGORIES

This parameter selects the effect category.

* For more information about effects, please refer to page 28.

* The MAIN zone lists two pages for EFX1 and EFX2.

2. **Type**

MAIN: 129 TYPES / SUB: 22 TYPES

This parameter selects the effect type.

* For more information about effects, please refer to page 28.

* The MAIN zone lists two pages for EFX1 and EFX2.

3. **Parameters**

N/A

These parameters change depending on the selected EFX type, and are used to adjust the mixing amount of the effected (wet) and bypassed (dry) sound, depth, speed, feedback, etc.

* For more information about effects, please refer to page 28.

2.2 Amp Simulator (MAIN zone)

1. Amp Type

5 TYPES

This parameter selects the simulated amplifier type.

* For more information about the various Amp Simulator model types, please refer to page 30.

3. Level

VALUE: 0 ~ 127

This parameter adjusts the volume of the simulated amplifier.

* For more information about the Amp Simulator, please refer to page 30.

4. Amp EQ Lo

VALUE: -10 dB ~ +10 dB

This parameter adjusts the level of the low frequencies of the simulated amplifier.

* This parameter functions independently of the global EQ.

* For more information about the Amp Simulator, please refer to page 31.

6. Amp EQ Hi

VALUE: -10 dB ~ +10 dB

This parameter adjusts the level of the high frequencies of the simulated amplifier.

* For more information about the Amp Simulator, please refer to page 31.

* This parameter functions independently of the global EQ.

8. Mic Type

CONDENSER, DYNAMIC

This parameter selects the type of microphone used for the simulated amplifier.

Mic Type	Description
Condenser	A microphone with a very broad frequency response that is typically found in studios.
Dynamic	A microphone with a more limited frequency response that is typically used for live playing.

* For more information about the Amp Simulator, please refer to page 31.

10. Ambience

VALUE: 0 ~ 127

This parameter adjusts the level (mix ratio) of an additional set of stereo microphones, that are placed away from the simulated amplifier in order to capture the ambient sound within a room.

* For more information about the Amp Simulator, please refer to page 31.

2. Drive

VALUE: 0 ~ 127

This parameter adjusts the amount of overdrive produced by the simulated amplifier.

* For more information about the Amp Simulator, please refer to page 30.

5. Amp EQ Mid

VALUE: -10 dB ~ +10 dB

This parameter adjusts the level of the mid frequencies of the simulated amplifier.

* This parameter functions independently of the global EQ.

* For more information about the Amp Simulator, please refer to page 31.

7. Mid Frequency

VALUE: 200 Hz ~ 3150 Hz

This parameter adjusts the mid frequency band of the simulated amplifier, levelled by the Amp EQ Mid parameter.

* For more information about the Amp Simulator, please refer to page 31.

* This parameter functions independently of the global EQ.

9. Mic Position

ON AXIS, OFF AXIS

This parameter selects the position of the microphone used for the simulated amplifier.

Mic Position	Description
On Axis	The microphone is placed in the centre of the speaker, producing a direct, aggressive sound with strong high/mid range.
Off Axis	The microphone is placed to the side of the speaker, producing a smoother and more ambient sound.

* For more information about the Amp Simulator, please refer to page 31.

3 Sound

1. **Master Volume**

VALUE: 0 ~ 127

This parameter adjusts the total SETUP volume, allowing the volume of multiple SETUPS to be balanced.

* This parameter is common for all four zones.

* This parameter is not stored to SOUND but to SETUP only.

3. **Filter Cut-off**

VALUE: -64 ~ +63

This parameter adjusts the frequency of the cut-off. Raising the cut-off level increases the brightness of the sound, while lowering the cut-off level results in a duller sound.

5. **DCA Attack Time**

VALUE: -64 ~ +63

This parameter adjusts the length of the attack. Higher values increase the attack time, resulting in a longer, slower attack for the selected sound.

7. **DCA Sustain Level**

VALUE: -64 ~ +63

This parameter adjusts the volume level of the sustain heard while the key is held for the selected sound.

9. **DCF Attack Time**

VALUE: -64 ~ +63

This parameter adjusts the length of the filter's attack. Higher values increase the attack time, resulting in a longer, slower attack for the filter.

11. **DCF Decay Time**

VALUE: -64 ~ +63

This parameter adjusts the length of the decay from peak level to sustain level for the filter.

13. **DCF Release Time**

VALUE: -64 ~ +63

This parameter adjusts the amount of time required for the filter to fade out after the keys are released.

15. **DCA Touch Depth**

VALUE: -64 ~ +63

This parameter adjusts how much the velocity affects the amplitude envelope depth.

2. **Panpot**

VALUE: L64 ~ R63

This parameter adjusts the left/right position of the selected sound within the stereo field.

4. **Filter Resonance**

VALUE: -64 ~ +63

This parameter adjusts the amount of the harmonic overtone around the cut-off frequency for the selected sound.

6. **DCA Decay Time**

VALUE: -64 ~ +63

This parameter adjusts the length of the decay from peak level to sustain level for the selected sound.

8. **DCA Release Time**

VALUE: -64 ~ +63

This parameter adjusts the amount of time required for the sound to fade out after the keys are released for the selected sound.

10. **DCF Attack Level**

VALUE: -64 ~ +63

This parameter adjusts the level of the filter's attack.

12. **DCF Sustain Level**

VALUE: -64 ~ +63

This parameter adjusts the level of the filter's sustain heard while the key is held for the selected sound.

14. **DCF Touch Depth**

VALUE: -64 ~ +63

This parameter adjusts how much the velocity affects the filter envelope depth.

* With the exception of Volume, the Sound parameters on these pages will not be available when tonewheel organ mode is selected.

■ About DCA Parameters

The DCA (Digitally Controlled Amplifier) parameters, are used to adjust the volume level of a sound over time using an envelope. The diagram below indicates the MP7SE's DCA parameters.

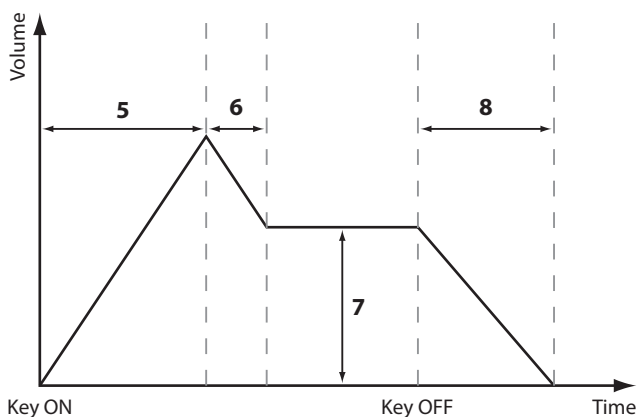

■ About DCF Parameters

The DCF (Digitally Controlled Filter) parameters, are used to adjust a low-pass filter applied to the sound over time. The diagram below indicates the MP7SE's DCF parameters.

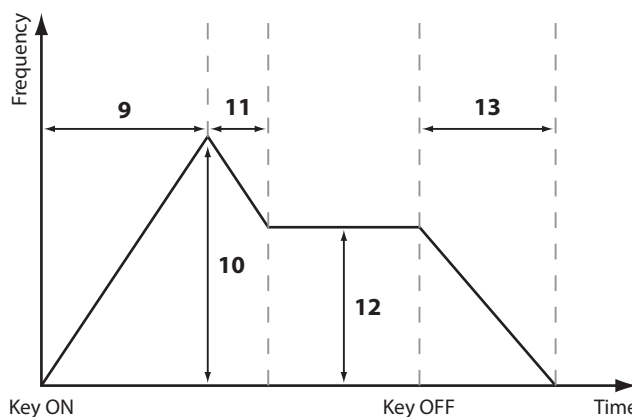

16. Vibrate Depth

VALUE: -64 ~ +63

This parameter adjusts the depth of the vibration applied to the selected sound.

18. Vibrate Delay

VALUE: -64 ~ +63

This parameter adjusts the delay time before the start of the vibration.

19. Octave Layer Switch

OFF, ON

This parameter turns the additional Octave Layer ON or OFF.

21. Octave Layer Range

VALUE: -2 ~ +2

This parameter sets the amount of octave transposition for the Octave Layer.

23. Portamento

OFF, ON

This parameter turns portamento playing ON or OFF.

Portamento describes the effect of pitch sliding from one note to another.

25. Portamento Mode

RATE, EQUAL

This parameter changes the portamento mode.

Portamento Mode	Description
Rate	The time required for the portamento will be variable. The distance between notes will affect the portamento time.
Equal	The time required for the portamento will be constant. The distance between notes will not affect the portamento time.

17. Vibrate Rate

VALUE: -64 ~ +63

This parameter adjusts the speed of the vibration applied to the selected sound.

20. Octave Layer Level

VALUE: 0 ~ 127

This parameter adjusts the volume level of the Octave Layer.

22. Octave Layer Detune

VALUE: -64 ~ +63

This parameter adjusts the tuning of the Octave Layer.

24. Portamento Time

VALUE: 0 ~ 127

This parameter adjusts the time required for the portamento (i.e. the speed of the 'slide' between notes).

3 Sound (MAIN zone, TONEWHEEL mode)

1. External Control OFF, MIDI CC# MIDI CH

This parameter determines whether or not the tonewheel organ drawbars can be adjusted by external MIDI devices. When set to CC# or MIDI Ch, an additional parameter page will appear, allowing CC# or MIDI channels to be assigned to each drawbar.

* This is a SYSTEM parameter and therefore memorised automatically. For more information about SYSTEM parameters, please refer to page 106.

2. MIDI CC# VALUE: CC#0 ~ CC#119

This parameter sets the CC# used for adjusting tonewheel organ drawbars when MIDI Control is set to MIDI Ch.

* This is a SYSTEM parameter and therefore memorised automatically. For more information about SYSTEM parameters, please refer to page 106.

■ MIDI CC# Drawbar Assign VALUE: CC#0 ~ CC#119

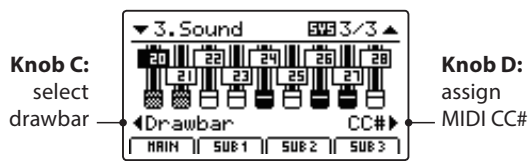

Turn control knob C to select the drawbar, and control knob D to assign the MIDI CC#.

■ MIDI Ch Drawbar Assign VALUE: 01CH ~ 16CH

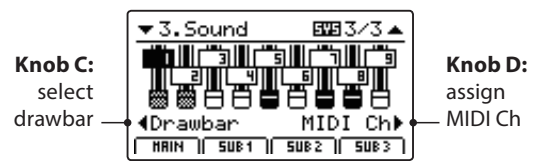

Turn control knob C to select the drawbar, and control knob D to assign the MIDI channel.

4 Tuning

1. Fine Tune

VALUE: -64 ~ +63

This parameter adjusts the tuning of the selected sound for values smaller than a semi-tone.

2. Stretch Tuning

9 TYPES + 5 USER

This parameter selects the level of stretch tuning.

The human ear typically detects high and low frequencies less accurately than those frequencies within the middle range. The tuning of an acoustic piano is therefore 'stretched' to compensate, ensuring that the sound will be heard more naturally to the ears.

* For information about creating User Stretch Tuning, please refer to the User Edit explanation in the SYSTEM menu chapter (page 115).

3. Temperament

7 TYPES + 2 USER

This parameter selects the tuning system of the selected sound.

* For information about creating User Temperaments, please refer to the User Edit explanation in the SYSTEM menu chapter (page 113).

4. Key of Temperament

RANGE: C ~ B

This parameter selects the key of the selected temperament. When using a temperament other than Equal Temperament, use this setting to specify the key signature of the piece.

* This parameter will only affect the 'balance' of the tuning system, the pitch of the keyboard will remain unchanged.

* With the exception of Fine Tune, the Tuning parameters on these pages will not be available when tonewheel organ mode is selected.

■ Temperament types

Temperament type	Description
Equal Temperament (Equal)	This is the most popular tuning method that divides the scale into twelve equal semi-tones. This produces the same chordal intervals in all twelve keys, and has the advantage of limitless modulation of the key. However, the tonality of each key becomes less characteristic and no chord is in pure consonance.
Pure Temperament (Pure Maj./Pure Min.)	This temperament, which eliminates dissonances for thirds and fifths is still popular for choral music because of its perfect harmony. When playing in a major key select 'Pure Maj' and when playing in a minor key select 'Pure Min'.
Pythagorean Temperament (Pythagorean)	This temperament, which uses mathematical ratios to eliminate dissonance for fifths, is very limited for use with chords, but it produces very characteristic melodic lines.
Meantone Temperament (Meantone)	This temperament, which uses a mean between a major and minor whole tone to eliminate dissonance for thirds, was devised to eliminate the lack of consonances experienced with certain fifths for the Mersenne pure temperament. It produces chords that are more beautiful than those with the equal temperament.
Werkmeister III Temperament (Werkmeis) Kirnberger III Temperament (Kirnberg)	These two temperaments are placed in between Meantone and Pythagorean. For music with few accidentals, this temperament produces the beautiful chords of the mean tone, but as accidentals increase, the temperament produces the characteristic melodies of the Pythagorean temperament. They are used primarily for classical music written in the Baroque era to revive the original characteristics.
User Temperament (Sys.User1/2)	User defined temperament created by raising or lowering the pitch for each semi-tone.

* For information about creating User Temperaments, please refer to the User Edit explanation in the SYSTEM menu chapter (page 113).

5 Key Setup

1. Touch Curve

6 TYPES + 5 USER

This parameter selects the touch response curve of the keyboard for the selected sound.

* For information about creating User Touch Curves, please refer to the User Edit explanation in the SYSTEM menu chapter (page 112).

* This parameter will not be available when tonewheel organ mode is selected.

2. Dynamics

VALUE: OFF, 1 ~ 10

This parameter adjusts the keyboard response (velocity compression) of the selected sound independently of the touch curve.

When the value is 10 (default), the keyboard response is normal. As the value decreases the keyboard response gradually becomes less dynamic, and when set to OFF becomes completely flat (i.e. fixed touch response).

■ Touch Curve types

Touch Curve	No.	Description
Light +	1	Requires less striking force to achieve a forte note. * This touch curve is intended for players with a very delicate touch.
Light	2	A louder volume is produced even when playing with a soft touch. * This touch curve is intended for players who are still developing finger strength.
Normal	3	Reproduces the standard touch sensitivity of a typical acoustic piano.
Heavy	4	Requires a heavier touch to produce a loud volume. * This touch curve is intended for players with stronger fingers.
Heavy +	5	Requires considerably more striking force to achieve a loud volume.
Off (constant)	6	A constant volume is produced regardless of how hard the keys are struck. * This touch curve is intended for playing sounds of instruments that have a fixed dynamic range (e.g. harpsichord).
User* (User 1~User 5)	-	A custom touch curve, created to suit an individual's personal playing style.

* For information about creating User touch curves, please refer to the User Edit explanation in the SYSTEM menu chapter (page 112).

■ Touch Curve graph

The illustration below provides a visual representation of the different Touch Curve types.

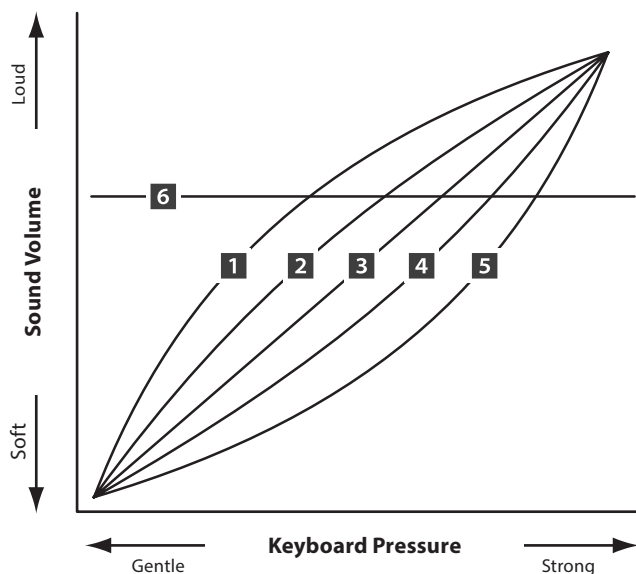

■ Dynamics graph

The illustration below provides a visual representation of the Dynamics parameter.

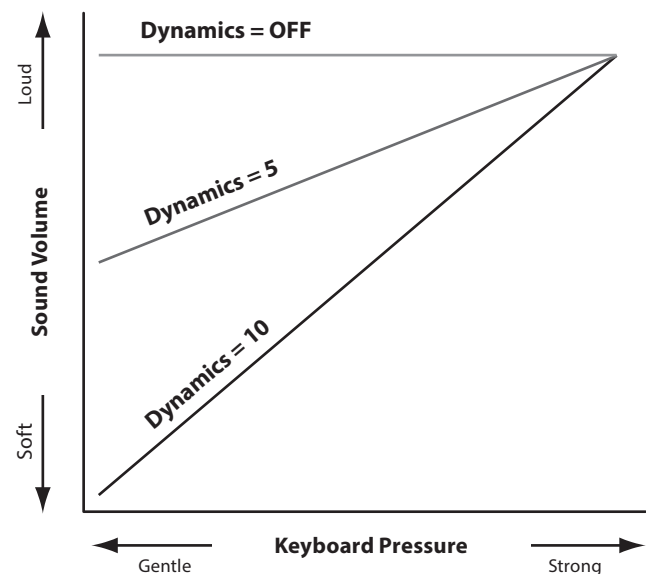

3. Trigger Mode

NORMAL, FAST

This parameter selects the trigger point for the keyboard.

A fast/higher trigger point may be useful when playing sounds that are traditionally played on non-weighted keyboards such as organ or synth.

Trigger Mode	Description
Normal	The keyboard trigger point is normal.
Fast	The keyboard trigger point is earlier than Normal.

* When either Fast mode is selected, all touch response functionality will be disabled, and an asterisk will be shown beside the relevant Touch Curve, Dynamics, Min.Touch, and VeloSW parameters.

* This parameter will only be visible for the MAIN zone, but when either Fast mode is selected will affect all zones.

7. Key Scaling Damping

ON, OFF

This parameter determines whether or not damping (velocity reduction) should be applied to a sound over a specific range.

This parameter may be useful when layering a piano sound with a strings sound, in order to reduce the level of the strings in the higher key range.

9. Key Range Zone Lo

RANGE: A0 ~ C8

This parameter defines the bottom key of the selected zone.

* For more information about adjusting the zone key range, please refer to page 24.

* This parameter is not stored to SOUND but to SETUP only.

4. Minimum Touch

VALUE: 1 ~ 20

This parameter adjusts the minimum key velocity required to produce a sound.

5. Octave Shift

VALUE: -3 ~ +3 OCTAVES

This parameter adjusts the amount of octave transposition for the selected sound.

* This parameter is not stored to SOUND but to SETUP only.

6. Zone Transpose

VALUE: -12 ~ +12

This parameter adjusts the amount of transposition for the selected zone.

* This parameter is not stored to SOUND but to SETUP only.

8. Key Scaling Key

RANGE: A0 ~ C8

This parameter defines the point on the keyboard from which Key Scaling Damping should be applied, up to the highest key.

10. Key Range Zone Hi

RANGE: A0 ~ C8

This parameter defines the top key of the selected zone.

* For more information about adjusting the zone key range, please refer to page 24.

* This parameter is not stored to SOUND but to SETUP only.

5 Key Setup (cont.)

11./12. Velocity Switch / Velocity Switch Value

MODE: OFF, SOFT, LOUD / VALUE: 0 ~ 127

These parameters enable velocity switching, and set the velocity switch type and value.

Velocity Switching is useful when combining multiple zones, allowing different sounds to be played depending on the velocity of the key strike.

* This parameter is not stored to SOUND but to SETUP only.

Switch Mode	Description
Off	The selected sound will play normally (i.e. no velocity switching).
Soft	The selected sound will play only when the velocity is lower than the defined velocity switch value.
Loud	The selected sound will play only when the velocity is higher than the defined velocity switch value.

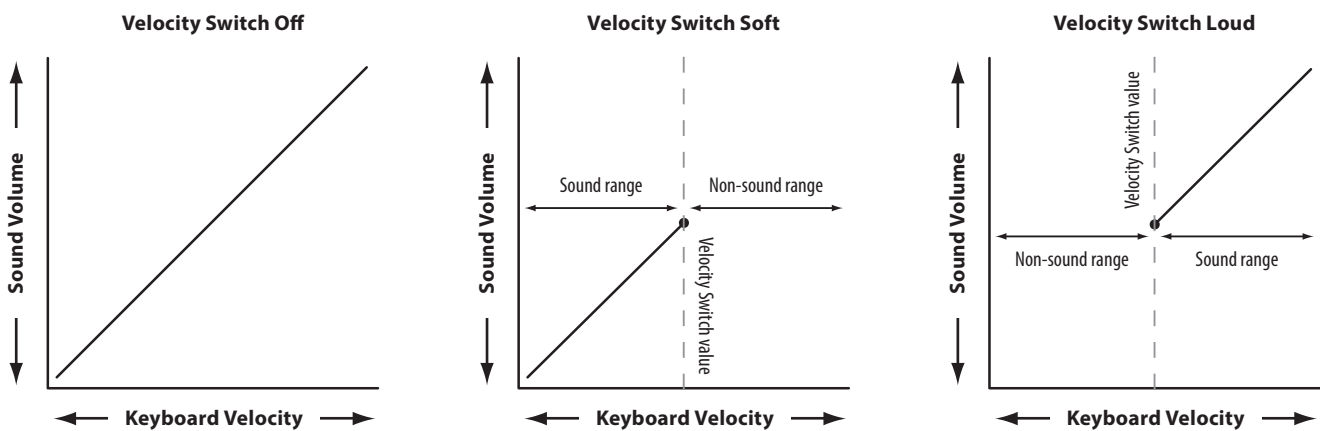

13. Solo

ON, OFF

This parameter determines whether or not playing will be restricted to single notes, even when more than one note is played simultaneously.

This parameters can be used to effectively simulate the performance characteristics of a monophonic synthesizer.

14. Solo Mode

LAST, HIGH, LOW

This parameter selects the solo mode for the selected zone.

Solo Mode	Description
Last	Play the last note of a group of notes.
High	Play the highest note of a group of notes.
Low	Play the lowest note of a group of notes.

15. Key Volume

5 TYPES + 5 USER

This parameter selects the Key Volume setting for the selected sound section, if desired.

* For information about creating User Key Volumes, please refer to the User Edit explanation in the SYSTEM menu chapter (page 114).

Key Volume	Description
Normal (default)	An evenly balanced volume throughout the keyboard.
High Damping	Gradually reduces the volume of the keyboard towards the treble region.
Low Damping	Gradually reduces the volume of the keyboard towards the bass region.
High & Low Damping	Gradually reduces the volume of the keyboard in both the treble and bass regions.
Center Damping	Gradually reduces the volume of the keyboard in the central region.
User	A custom keyboard volume, allowing the volume of each key to be individually adjusted.

6 Controllers

1. Damper Pedal

ON, OFF

This parameter determines whether or not the included F-10H damper pedal is active for the selected sound.

* For more information about connecting pedals, please refer to page 17.

3. Damper Pedal Mode

NORMAL, HOLD

This parameter determines whether or not the damper pedal should sustain sounds indefinitely without decay.

4. Pitch Bend

ON, OFF

This parameter determines whether or not the pitch bend wheel is active for the selected sound.

6. Soft Pedal Depth

VALUE: 1 ~ 10

This parameter adjusts the effectiveness (i.e. depth/strength) of the soft pedal.

7. Modulation Wheel

ON, REVERSE, OFF

This parameter determines whether or not the modulation wheel is active for the selected sound.

When set to 'Reverse', the wheel's output values will be inverted.

9. Modulation Depth Range

VALUE: 0 ~ 127

This parameter sets the range of the pitch modulation function in steps of 600/127 cents.

10. SW1 Button

ON, OFF

This parameter determines whether or not the SW1 button is active for the selected sound.

12. SW2 Button

ON, OFF

This parameter determines whether or not the SW2 button is active for the selected sound.

2. Damper Pedal Assign

28 FUNCTIONS (MAIN)
18 FUNCTIONS (SUB)

This parameter selects the function assigned to the included F-10H damper pedal.

* This parameter is common for all four zones.

5. Pitch Bend Range

VALUE: 0 ~ 7

This parameter sets the range of the pitch bend wheel in semi-tone steps.

* The range differs for INT mode (0 ~7) and EXT mode (0~12).

8. Modulation Wheel Assign

28 FUNCTIONS (MAIN)
18 FUNCTIONS (SUB)

This parameter selects the function assigned to the MP7SE's modulation wheel.

11. SW1 Button Assign

10 FUNCTIONS

This parameter selects the function assigned to the SW1 button.

* This parameter is common for all four zones.

13. SW2 Button Assign

10 FUNCTIONS

This parameter selects the function assigned to the SW2 button.

* This parameter is common for all four zones.

EDIT Menu parameters (INT mode)

14. Footswitch Pedal

ON, OFF

This parameter determines whether or not the footswitch pedal (if connected) is active for the selected sound.

* For more information about connecting pedals, please refer to page 18.

16. Expression Pedal

ON, REVERSE, OFF

This parameter determines whether or not the expression pedal (if connected) is active for the selected sound.

When set to 'Reverse', the pedal's output values will be inverted.

* For more information about connecting pedals, please refer to page 17.

18. Right Pedal

ON, OFF

This parameter determines whether or not the right pedal of the optional GFP-3 pedal unit is active for the selected sound.

* For more information about connecting pedals, please refer to page 17.

20. Center Pedal

ON, OFF

This parameter determines whether or not the centre pedal of the optional GFP-3 pedal unit is active for the selected sound.

* For more information about connecting pedals, please refer to page 17.

22. Left Pedal

ON, OFF

This parameter determines whether or not an ordinary foot switch pedal or the left pedal of the optional GFP-3 pedal unit is active for the selected sound.

* For more information about connecting pedals, please refer to page 17.

15. Footswitch Pedal Assign

28 FUNCTIONS (MAIN)
18 FUNCTIONS (SUB)

This parameter selects the function assigned to the footswitch pedal (if connected).

* This parameter is common for all four zones.

17. Expression Pedal Assign

28 FUNCTIONS (MAIN)
18 FUNCTIONS (SUB)

This parameter selects the function assigned to the expression pedal (if connected).

* This parameter is common for all four zones.

19. Right Pedal Assign

28 FUNCTIONS (MAIN)
18 FUNCTIONS (SUB)

This parameter selects the function assigned to the right pedal of the optional GFP-3 pedal unit.

* This parameter is common for all four zones.

21. Center Pedal Assign

28 FUNCTIONS (MAIN)
18 FUNCTIONS (SUB)

This parameter selects the function assigned to the centre pedal of the optional GFP-3 pedal unit.

* This parameter is common for all four zones.

23. Left Pedal Assign

28 FUNCTIONS (MAIN)
18 FUNCTIONS (SUB)

This parameter selects the function assigned to an ordinary foot switch pedal or the left pedal of the optional GFP-3 pedal unit.

* This parameter is common for all four zones.

■ Assignable pedal/mod. wheel functions

Function
Modulation
Panpot
Expression
Damper
Sostenuto
Soft
Resonance
Cut-off

EFX1 Parameter 1 ~ 10, EFX2 Parameter 1 ~ 10 (MAIN)
EFX Parameter 1 ~ 10 (SUB)

■ Assignable SW1/SW2 button functions

Function
Octave Layer
Rotary Slow/Fast
Solo
Portamento
Pitch Bend Lock
Modulation Wheel Lock
Center Pedal Lock
Left Pedal Lock
Expression Pedal Lock
Tonewheel Control

7 Knob Assign

The Knob Assign screen is used to assign EDIT menu parameters to the four main control knobs A, B, C, and D for direct, real-time adjustment in Play Mode. Two groups of knob parameters (primary and secondary) can be assigned to each of the four zones, providing extensive control over the selected sounds.

Assigning parameters to each knob

Enter the Knob Assign screen for the desired section.

Turn the four control knobs (A, B, C, D) to specify which parameter should be assigned to each control knob in Play Mode.

Parameters can also be assigned by using the CURSOR buttons to move the selection cursor, and +/YES or -/NO buttons to cycle through the available parameters.

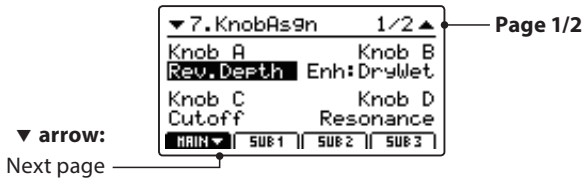
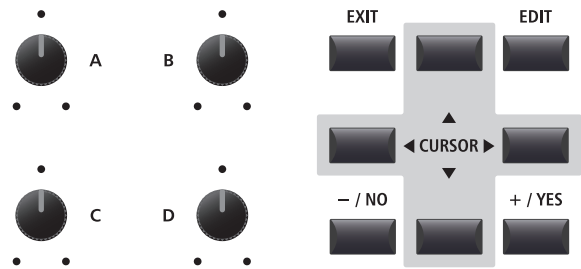

Press the F1~F4 function buttons (depending on the selected zone) or CURSOR ▲▼ buttons to show the secondary group of knob parameters in the LCD display.

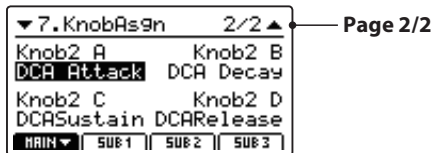
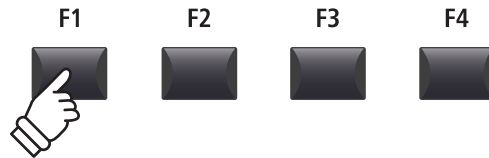

* Assignable parameters differ slightly for each sound section. For a full list of assignable parameters, please refer to the page 150.

* For more information about adjusting parameters in Play Mode, please refer to page 26.

About EFX parameter placeholder names (EFX Para1~10)

Some EFX offer a wide range of available parameters, while others are less flexible and feature fewer adjustable parameters. When assigning EFX parameters to the four control knobs, the names of the available parameters for the selected EFX (e.g. Wah:LowEQ) will be shown.

If the selected EFX features a smaller number of available parameters, a placeholder name (e.g. 'EFX Para 5') will be substituted in the Knob Assign menu, and the knob will become inactive in the main play screen.

<p>Knob Assign screen ClassichTch Wah selected, LowEQ parameter assigned to control knob D.</p>	→	<p>Knob Assign screen LpfPd1 Wah selected, control knob D changes to EFX Para5 parameter (i.e. inactive).</p>
<p>Play screen ClassichTch Wah selected, control knob D shows Wah:LowEQ parameter.</p>	→	<p>Play screen LpfPd1 Wah selected, control knob D changes to EFX Para5 (i.e. inactive).</p>

8 Virtual Technician (PIANO sounds)

1. Voicing

6 TYPES + 5 USER

This parameter attempts to recreate the technique of adjusting the action, hammers and strings of an acoustic piano, allowing the tonal character and dynamics of the MP7SE's piano sounds to be dramatically altered.

■ Voicing types

Voicing Type	Description
Normal	The normal tonal character of an acoustic piano throughout the entire dynamic range.
Mellow 1	A softer, more mellow tonal character throughout the entire dynamic range.
Mellow 2	An even softer tonal character than Mellow 1.
Dynamic	A tonal character that changes dramatically from mellow to bright, depending on the strength of key strike.
Bright 1	A bright tonal character throughout the entire dynamic range.
Bright 2	An even brighter tonal character than Bright 1.
User	A custom tonal character, allowing each key to be individually voiced.

* For information about creating User Voicing, please refer to the User Edit explanation in the SYSTEM menu chapter (page 116).

2. String Resonance

VALUE: OFF, 1 ~ 10

This parameter adjusts the volume of the string resonance.

String Resonance refers to a phenomenon that exists in acoustic pianos whereby the strings of held notes resonate 'sympathetically' with other notes of the same harmonic series.

3. Undamped Resonance

VALUE: OFF, 1 ~ 10

This parameter adjusts the volume of the undamped resonance.

The dampers of an acoustic piano span almost the full width of the keyboard. However, the topmost 18 keys (approximately 1.5 octaves) do not incorporate dampers, as the shorter strings for these treble notes decay quickly and therefore do not need to be dampened. As a result, the strings of these 'undamped' treble notes are free to vibrate in sympathetic resonance with those of lower keys – independently of the damper pedal position – helping to enrich the sound with additional harmonics and tonal colour.

4. Damper Resonance

VALUE: OFF, 1 ~ 10

This parameter adjusts the volume of the damper resonance.

Depressing the damper pedal of an acoustic piano raises all dampers, allowing the strings to vibrate freely. When a note or chord is played on the piano with the sustain pedal depressed, not only will the strings of the notes played vibrate, but also the strings of other notes, vibrating in sympathetic resonance.

5. Key-off Effect

VALUE: OFF, 1 ~ 10

This parameter adjusts the volume of the key-off effect.

When playing an acoustic piano – particularly in the bass region of the keyboard – if a key is played with force and released quickly, it is often possible to hear the faint sound of the damper touching the strings immediately before the vibrations are stopped.

6. Damper Noise

VALUE: OFF, 1 ~ 10

This parameter adjusts the volume of the damper noise.

When the damper pedal is depressed and released, it is often possible to hear the sound of the damper head touching and releasing the strings.

7. Hammer Delay

VALUE: OFF, 1 ~ 10

This parameter adjusts the delay of the hammer striking the string when playing with pianissimo.

8. Fall-back Noise

VALUE: OFF, 1 ~ 10

This parameter adjusts the volume of the noise heard when the keyboard action 'falls back' after a key is released.

9. Topboard

CLOSE, OPEN1, OPEN2, OPEN3

This parameter changes the position of the piano's topboard.

When playing an acoustic grand piano, the position of the instrument's topboard (lid) affects both the volume and 'openness' of the tone produced. A fully open topboard allows sound waves to reflect off the polished lid surface and project into the room, while a closed lid has the opposite effect, resulting in a darker, more opaque tone.

10. Stereo Width

VALUE: 0 ~ 127

This parameter adjusts the width of the stereo sound.

Virtual Technician (E.PIANO, HARPSICHORD, BASS sounds)

1. Key-off Noise

VALUE: OFF, 1 ~ 127

When an E.PIANO category sound is selected, this parameter adjusts the volume of the noise heard when the keys of an electromechanical instrument are released.

When a harpsichord or bass sound is selected this parameter adjusts the volume of the release noise for harpsichord and bass sounds.

2. Key-off Delay

VALUE: 0 ~ 127

This parameter adjusts the delay time before the Key-off Noise is heard.

Virtual Technician (DRAWBAR sounds)

1. Key Click Level

VALUE: OFF, 1 ~ 127

This parameter adjusts the volume of the key click sound when playing drawbar organ sounds.

2. Wheel Noise Level

VALUE: 0 ~ 127

This parameter adjusts the volume of the ambient noise produced by the organ's spinning tonewheels.

Increase the value of this parameter to give the tonewheel organ a more vintage character.

Overview of the EDIT Menu (EXT mode)

The EDIT menu can also be used to adjust parameters for zones in EXT mode. As with the INT mode EDIT menus, the parameters are grouped by category, providing direct control over any connected MIDI devices.

As with zones set to INT mode, this collection of parameters, together with other adjustable settings, can be stored as a SETUP memory (page 65). The MP7SE provides 256 user programmable SETUP memories.

About Common parameters (E icon)

Unless stated, parameter settings for the MAIN, SUB1, SUB2, and SUB3 zones are independent for each zone. However, parameters marked with a E icon are common for all four zones. For example, changing the E Right Pedal Assign parameter for the MAIN zone will automatically change the E Right Pedal Assign parameter for the SUB1, SUB2, and SUB3 zones.

About System parameters (SYS icon)

EXT mode zone parameters marked with a SYS icon are SYSTEM parameters and memorised automatically, without the need to use the STORE function.

EXT mode zone parameters

No.	Category	Parameters
1	Channel/Program	MIDI Transmitting Channel, Program, Bank MSB, Bank LSB
2	SETUP	Send Program, Send Bank, Send Volume, Send Knobs
3	Transmit SYS	Transmit System Exclusive, Transmit Recorder, Fader Assign
4	MMC SYS	Transmit MMC, MMC Device ID, MMC Commands
5	Key Setup	Touch Curve, Dynamics, Trigger Mode, Octave Shift, Zone Transpose, Key Scaling Damping, Key Scaling Key, Key Range Zone Lo, Key Range Zone Hi, Velocity Switch, Velocity Switch Value, Solo, Solo Mode, Transmit Keyboard
6	Controllers	Damper Pedal, E Damper Pedal Assign, Half Pedal Values, Pitch Bend, Pitch Bend Range, Modulation Wheel, Modulation Wheel Assign, Modulation Wheel Range, Footswitch Pedal, E Footswitch Pedal Assign, Expression Pedal, E Expression Pedal Assign, Right Pedal, E Right Pedal Assign, Center Pedal, E Center Pedal Assign, Left Pedal, E Left Pedal Assign
7	Knob Assign	Knob A Assign, Knob B Assign, Knob C Assign, Knob D Assign, Knob2 A Assign, Knob2 B Assign, Knob2 C Assign, Knob2 D Assign

Entering the EDIT Menu

When the zone is in EXT mode:

Press the EDIT button.

The LED indicator for the EDIT button will turn ON, and the Edit Menu for the selected zone will be shown in the LCD display.

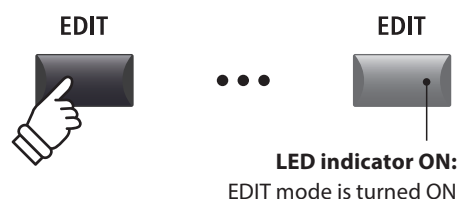

* To change the selected zone, press the F1~F4 buttons.

■ Selecting the parameter category

After entering the EDIT Menu:

Press the CURSOR buttons to select the desired category, then press the +/YES button to enter the selected category.

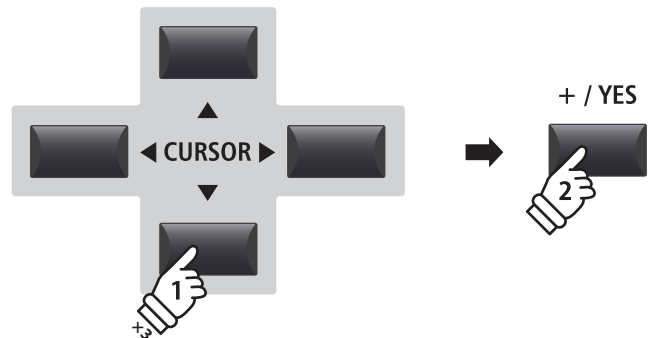
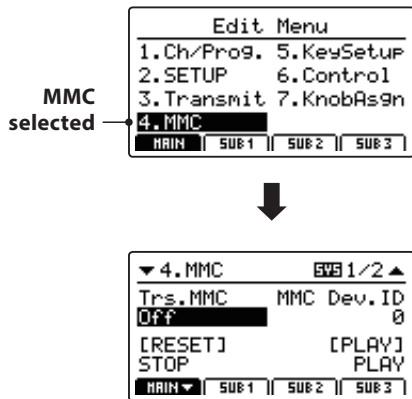

Example: To enter the MMC category, press the CURSOR▼ button three times, then press the +/YES button.

■ Adjusting parameters

After selecting the parameter category:

Turn the four control knobs (A, B, C, D) to adjust the parameters assigned to those knob.

Parameters can also be adjusted by using the CURSOR buttons to move the selection cursor, and +/YES or -/NO buttons to increase or decrease the value of the selected parameter.

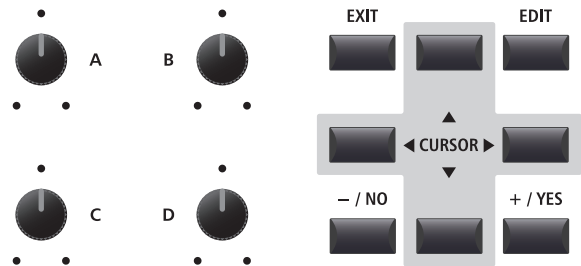

Press the EXIT button to exit the parameter category, or return to the Play Mode screen.



EDIT Menu parameters (EXT mode)

1 Channel/Program

1. MIDI Transmitting Channel VALUE: 01CH ~ 16CH

This parameter determines which MIDI channel will be used to transmit event information for the selected zone.

* By default, SUB2 and SUB3 zones are assigned MIDI channels 01 and 02. MAIN and SUB1 zones are assigned MIDI channels 03 and 04.

* The specified MIDI transmit channel should match the MIDI Receive channel of the connected MIDI device.

2. Program VALUE: 1 ~ 128

This parameter determines which Program Change Number will be transmitted when a SETUP is recalled. For example, the desired Program number of a sound on the external MIDI device.

3/4. Bank MSB/Bank LSB VALUE: 0 ~ 127

This parameter determines which MSB and LSB number will be transmitted when a SETUP is recalled. The MIDI standard allocates 128 storage spaces, however this number can be expanded using an MSB and an LSB.

The diagram to the right illustrates how the Program Number, MSB Bank, and LSB Bank are organised.

* Please refer to the owner's manual of the connected MIDI device for further information.

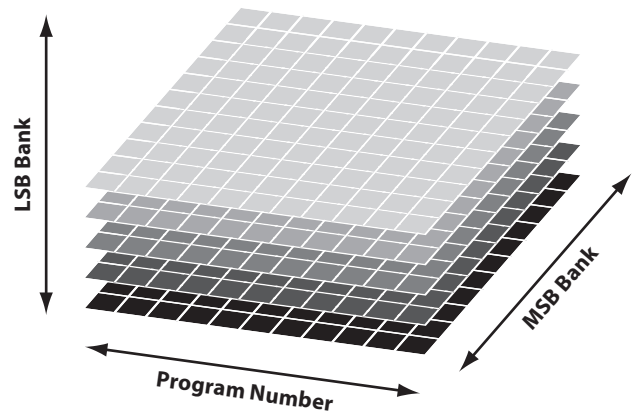

2 SETUP

1. Send Program ON, OFF

This parameter determines whether or not a Program Change Number will be transmitted when a SETUP is recalled.

To change sounds on external MIDI devices when recalling a SETUP, set this parameter to ON.

2. Send Bank ON, OFF

This parameter determines whether or not Program Bank Numbers (MSB, LSB) will be transmitted when a SETUP is recalled.

If the external MIDI device requires a Bank Select message, set this parameter to ON.

3. Send Volume ON, OFF

This parameter determines whether or not an initial MIDI Volume message will be transmitted when a SETUP is recalled.

* Adjusting the volume of a zone by turning the control knobs will still transmit values even if this parameter is set to OFF.

4. Send Knobs ON, OFF

This parameter determines whether or not control knob settings will be transmitted (ON) or not (OFF) when a SETUP is recalled.

* Turning the control knobs will still transmit values even if this parameter is set to OFF.

■ SETUP parameters in the SYSTEM menu

The above Send parameters can be overridden by the SETUP Program, SETUP Bank, SETUP Volume, SETUP Knobs parameters in the MIDI category of the SYSTEM menu (page 110).

When these SETUP parameters are set to OFF, an asterisk will be shown beside the relevant Send parameter to indicate that the EDIT menu setting is being overridden.

Asterisk:
Parameter is overridden by SETUP menu

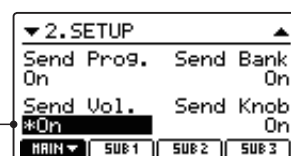

3 Transmit

The Transmit category parameters are all SYSTEM parameters. These parameters are memorised automatically and therefore do not need to be stored to each SETUP.

1. Transmit System Exclusive ON, OFF

This parameter determines whether or not System Exclusive (SYSEX) data will be transmitted to an external MIDI device.

* For more information about System Exclusive data transmitted by the MP7SE, please refer to page 141.

2. Transmit Recorder ON, OFF

This parameter determines whether or not data will be transmitted to an external MIDI device when playing internal recorder songs.

3. Fader Assign CC#0 ~ CC#119, AFTERTOUCH

This parameter selects the function assigned to the zone's fader.

* By default, the fader for an EXT mode zone is set to CC#07 (Volume).

4 MMC

The MMC category parameters are all SYSTEM parameters. These parameters are memorised automatically and therefore do not need to be stored to each SETUP.

1. Transmit MMC ON, OFF

This parameter determines whether or not the MP7SE's recorder control buttons will transmit MMC (MIDI Machine Control) data.

2. MMC Dev. ID VALUE: 0 ~ 127

This parameter determines the device ID of the MMC (MIDI Machine Control).

3. MMC Commands 13 MMC COMMANDS, 3 REALTIME COMMANDS

These parameters allow MMC or Realtime commands to be assigned to the MP7SE's six recorder control buttons.

* By default, the main MMC commands should be correctly mapped to the MP7SE's recorder control buttons.

■ Assignable recorder control commands

MMC Commands			
01	STOP	08	RECORD PAUSE
02	PLAY	09	PAUSE
03	DEFERRED PLAY	0A	EJECT
04	FAST FORWARD	0B	CHASE
05	REWIND	0C	COMMAND ERROR RESET
06	RECORD STROBE	0D	MMC RESET
07	RECORD EXIT		

Realtime Commands	
FA	Realtime START
FB	Realtime CONTINUE
FC	Realtime STOP

■ Recorder control buttons

The illustration below indicates the names of the six recorder control buttons:

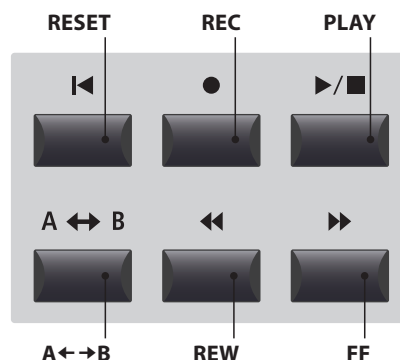

5 Key Setup

1. Touch Curve

6 TYPES + 5 USER

This parameter selects the touch response curve of the keyboard for the selected zone.

- * For more information about touch curve types, please refer to page 46.
- * For information about creating User Touch Curves, please refer to the User Edit explanation in the SYSTEM menu chapter (page 112).
- * This parameter will not be available when tonewheel organ mode is selected.

3. Trigger Mode

NORMAL, FAST

This parameter selects the trigger point for the keyboard.

A fast/higher trigger point may be useful when playing sounds that are traditionally played on non-weighted keyboards such as organ or synth.

Trigger Mode	Description
Normal	The keyboard trigger point is normal.
Fast	The keyboard trigger point is earlier than normal.

- * When either Fast mode is selected, all touch response functionality will be disabled, and an asterisk will be shown beside the relevant Touch Curve, Dynamics, Min.Touch, and VeloSW parameters.
- * This parameter will only be visible for the MAIN zone, but when either Fast mode is selected will affect all zones.

6. Key Scaling Damping

ON, OFF

This parameter determines whether or not damping (velocity reduction) should be applied to a zone over a specific range.

This parameter may be useful when layering a piano sound with a strings sound, in order to reduce the level of the strings in the higher key range.

8. Key Range Zone Lo

RANGE: A0 ~ C8

This parameter defines the bottom key of the selected zone.

- * For more information about adjusting the zone key range, please refer to page 24.

2. Dynamics

VALUE: OFF, 1 ~ 10

This parameter adjusts the keyboard response (velocity compression) of the selected zone independently of the touch curve.

When the value is 10 (default), the keyboard response is normal. As the value decreases the keyboard response gradually becomes less dynamic, and when set to OFF becomes completely flat (i.e. fixed touch response).

- * For more information about dynamics, please refer to page 46.

4. Octave Shift

VALUE: -3 ~ +3 OCTAVES

This parameter adjusts the amount of octave transposition for the selected zone.

5. Zone Transpose

VALUE: -12 ~ +12

This parameter adjusts the amount of transposition for the selected zone.

7. Key Scaling Key

RANGE: A0 ~ C8

This parameter defines the point on the keyboard from which Key Scaling Damping should be applied, up to the highest key.

9. Key Range Zone Hi

RANGE: A0 ~ C8

This parameter defines the top key of the selected zone.

- * For more information about adjusting the zone key range, please refer to page 24.

10./11. Velocity Switch / Velocity Switch Value

MODE: OFF, SOFT, LOUD / VALUE: 0 ~ 127

These parameters enable velocity switching, and set the velocity switch type and value.

Velocity Switching is useful when combining multiple zones, allowing different sounds to be played depending on the velocity of the key strike.

Switch Mode	Description
Off	The selected sound will play normally (i.e. no velocity switching).
Soft	The selected sound will play only when the velocity is lower than the defined velocity switch value.
Loud	The selected sound will play only when the velocity is higher than the defined velocity switch value.

* For more information about velocity switching, please refer to page 48.

12. Solo

ON, OFF

This parameter determines whether or not playing will be restricted to single notes, even when more than one note is played simultaneously.

This parameters can be used to effectively simulate the performance characteristics of a monophonic synthesizer.

14. Transmit Keyboard

ON, OFF

This parameter determines whether or not keyboard Key ON/Key OFF event data will be transmitted to an external MIDI device.

13. Solo Mode

LAST, HIGH, LOW

This parameter selects the solo mode for the selected zone.

Solo Mode	Description
Last	Play the last note of a group of notes.
High	Play the highest note of a group of notes.
Low	Play the lowest note of a group of notes.

6 Controllers

1. Damper Pedal ON, OFF

This parameter determines whether or not the included F-10H damper pedal is active for the selected zone.

* For more information about connecting pedals, please refer to page 17.

2. Damper Pedal Assign CC#0 ~ CC#119, AFTERTOUCH

This parameter selects the function assigned to the included F-10H damper pedal.

* This parameter is common for all four zones.

3. Half Pedal Values NORMAL, HIGH, LOW, MID HIGH, MID LOW

This parameter changes the half pedal ranges sent by the included F-10H damper pedal for the selected zone.

This parameter is useful when using the MP7SE to control external tone generators (e.g. software pianos) that respond to damper pedal behaviour differently.

Half Pedal Value	Value Range	Description
Normal (default)	0 ~ 127	The damper pedal sends a full range of evenly distributed values.
High	0, 64 ~ 127	The damper pedal sends a full range of evenly distributed values after the half-pedal point is reached.
Low	0 ~ 63, 127	The damper pedal sends a full range of evenly distributed values before the half-pedal point is reached.
Mid High	0, 50 ~ 100, 127	The damper pedal sends a full range of evenly distributed values between 50 and 100.
Mid Low	0, 25 ~ 75, 127	The damper pedal sends a full range of evenly distributed values between 25 and 75.

4. Pitch Bend ON, OFF

This parameter determines whether or not the pitch bend wheel is active for the selected zone.

5. Pitch Bend Range VALUE: 0 ~ 12

This parameter sets the range of the pitch bend wheel in semi-tone steps.

* The range differs for INT mode (0 ~7) and EXT mode (0~12).

6. Modulation Wheel ON, REVERSE, OFF

This parameter determines whether or not the modulation wheel is active for the selected zone.

When set to 'Reverse', the wheel's output values will be inverted.

7. Modulation Wheel Assign CC#0 ~ CC#119, AFTERTOUCH

This parameter selects the function assigned to the MP7SE's modulation wheel.

8. Modulation Depth Range VALUE: 0 ~ 127

This parameter sets the range of the pitch modulation function in steps of 600/127 cents.

9. Footswitch Pedal ON, OFF

This parameter determines whether or not the footswitch pedal (if connected) is active for the selected sound.

* For more information about connecting pedals, please refer to page 18.

10. Footswitch Pedal Assign CC#0 ~ CC#119, AFTERTOUCH

This parameter selects the function assigned to the footswitch pedal (if connected).

* This parameter is common for all four zones.

11. Expression Pedal

ON, REVERSE, OFF

This parameter determines whether or not the expression pedal (if connected) is active for the selected zone.

When set to 'Reverse', the pedal's output values will be inverted.

* For more information about connecting pedals, please refer to page 17.

13. Right Pedal

ON, OFF

This parameter determines whether or not the right pedal of the optional GFP-3 pedal unit is active for the selected zone.

* For more information about connecting pedals, please refer to page 17.

15. Center Pedal

ON, OFF

This parameter determines whether or not the centre pedal of the optional GFP-3 pedal unit is active for the selected zone.

* For more information about connecting pedals, please refer to page 17.

17. Left Pedal

ON, OFF

This parameter determines whether or not the left pedal of the optional GFP-3 pedal unit is active for the selected zone.

* For more information about connecting pedals, please refer to page 17.

12. Expression Pedal Assign

CC#0 ~ CC#119,
AFTERTOUC

This parameter selects the function assigned to the expression pedal (if connected).

* This parameter is common for all four zones.

14. Right Pedal Assign

CC#0 ~ CC#119,
AFTERTOUC

This parameter selects the function assigned to the right pedal of the optional GFP-3 pedal unit.

* This parameter is common for all four zones.

16. Center Pedal Assign

CC#0 ~ CC#119,
AFTERTOUC

This parameter selects the function assigned to the centre pedal of the optional GFP-3 pedal unit.

* This parameter is common for all four zones.

18. Left Pedal Assign

CC#0 ~ CC#119,
AFTERTOUC

This parameter selects the function assigned to the left pedal of the optional GFP-3 pedal unit.

* This parameter is common for all four zones.

7 Knob Assign

The Knob Assign screen is used to assign MIDI Control Change or Aftertouch messages to the four main control knobs A, B, C, and D for direct, real-time adjustment in Play Mode. Two groups of knob parameters (primary and secondary) can be assigned to each of the four zones, providing extensive control over external MIDI devices.

Assigning MIDI CC/Aftertouch messages to each knob

Enter the Knob Assign screen for the desired section.

Turn the four control knobs (A, B, C, D) to specify which MIDI CC message should be assigned to each control knob.

MIDI CC messages can also be assigned by using the CURSOR buttons to move the selection cursor, and +/-YES or -/NO buttons to increase or decrease the values.

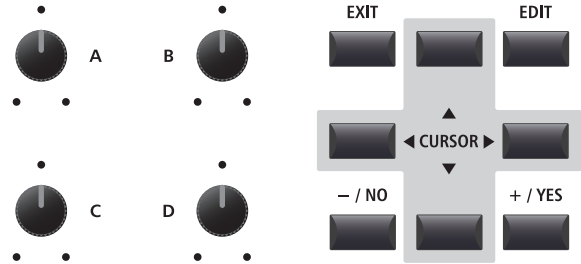

EDIT Menu

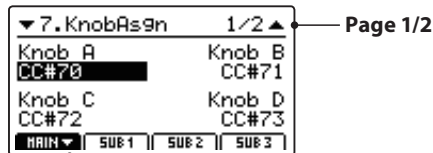

Press the F1~F4 buttons (depending on the selected zone) to show the secondary group of knob parameters in the LCD display.

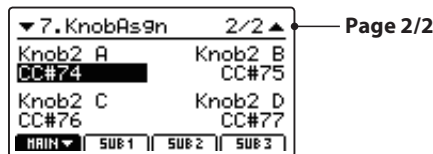

* For more information about adjusting parameters in Play Mode, please refer to page 26.

Overview of the EDIT Menu (BOTH mode)

When a zone is set to BOTH mode, the EDIT menu will display a combination of INT mode and EXT mode parameters. The first eight categories will contain normal INT mode parameters, with an additional four categories containing EXT mode parameters.

* For more information about INT mode and EXT mode parameters please refer to pages 38 and 54.

As with zones set to INT and EXT mode, this collection of parameters, together with other adjustable settings, can be stored as a SETUP memory (page 65). The MP7SE provides 256 user programmable SETUP memories.

About Common parameters (🔑 icon)

Unless stated, parameter settings for the MAIN, SUB1, SUB2, and SUB3 zones are independent for each zone. However, parameters marked with a 🔑 icon are common for all four zones. For example, changing the 🔑 Right Pedal Assign parameter for the MAIN zone will automatically change the 🔑 Right Pedal Assign parameter for the SUB1, SUB2, and SUB3 zones.

About System parameters (🔧 icon)

EXT mode zone parameters marked with a 🔧 icon are SYSTEM parameters and memorised automatically, without the need to use the STORE function.

BOTH mode zone parameters

No.	Category	Parameters	
INT mode parameters	1	REVERB	🔑Type, 🔑Pre Delay, 🔑Time, Depth
	2	EFX	Category, Type, Parameters (prm1~prm10, depending on EFX type)
		AMP	Amp Type, Drive, Level, Amp EQ Lo, Amp EQ Mid, Amp EQ Hi, Mid Freq., Mic Type, Mic Position, Ambience
	3	Sound	Volume, Panpot, Filter Cut-off, Filter Resonance, DCA Attack Time, DCA Decay Time, DCA Sustain Level, DCA Release Time, DCF Attack Time, DCF Attack Level, DCF Decay Time, DCF Sustain Level, DCF Release Time, DCF Touch Depth, DCA Touch Depth, Vibrate Depth, Vibrate Rate, Vibrate Delay, Octave Layer Switch, Octave Layer Level, Octave Layer Range, Octave Layer Detune, Portamento, Porta. Time, Porta. Mode TONEWHEEL: Drawbar Position, Percussion, Perc. Level, Perc. Decay, Perc. Harmonic, Volume, 🔧Ext. Control
	4	Tuning	Fine Tune, Stretch Tuning, Temperament, Key of Temperament
	5	Key Setup	Touch Curve, Dynamics, Trigger Mode, Minimum Touch, Octave Shift, Zone Transpose, Key Scaling Damping, Key Scaling Key, Key Range Zone Lo, Key Range Zone Hi, Velocity Switch, Velocity Switch Value, Solo, Solo Mode, Key Volume
	6	Controllers	Damper Pedal, 🔑Damper Pedal Assign, Damper Pedal Mode, Pitch Bend, P. Bend Range, Soft Pedal Depth, Modulation Wheel, Modulation Wheel Assign, Modulation Depth Range, SW1 Button, 🔑SW1 Button Assign, SW2 Button, 🔑SW2 Button Assign, Footswitch Pedal, 🔑Footswitch Pedal Assign, Expression Pedal, 🔑Expression Pedal Assign, Right Pedal, 🔑Right Pedal Assign, Center Pedal, 🔑Center Pedal Assign, Left Pedal, 🔑Left Pedal Assign
	7	Knob Assign	Knob A Assign, Knob B Assign, Knob C Assign, Knob D Assign, Knob2 A Assign, Knob2 B Assign, Knob2 C Assign, Knob2 D Assign
8	Virtual Technician	PIANO: Voicing, String Resonance, Undamped Resonance, Damper Resonance, Key-off Effect, Damper Noise, Hammer Delay, Fall-back Noise, Topboard, Stereo Width E.PIANO/HARPSI/BASS: Key-off Noise, Key-off Delay DRAWBAR*: Key Click Level, Wheel Noise Level	
EXT mode	9	Ch/Program	MIDI Transmitting Channel, Program*, Bank MSB*, Bank LSB*
	10	SETUP	Send Program, Send Bank, Send Volume, Send Knobs
	11	Transmit 🔧	Transmit System Exclusive, Transmit Recorder
	12	MMC 🔧	Transmit MMC, MMC Device ID, MMC Commands

* When a zone is set to BOTH mode, the Program, Bank MSB, and Bank LSB parameters are fixed, and cannot be adjusted.

Overview of the STORE Button

After using the EDIT menu and control knobs to adjust the parameters for the selected sound/zone, the STORE button is used to memorise the settings, and ensure the changes are not lost when turning the instrument OFF or selecting other sounds.

The STORE button has three different functions: to store individual sounds (SOUND), to store the entire panel configuration (SETUP), and to store the current panel configuration as the default (POWERON).

■ STORE button functions

STORE function	Description
SOUND	Store the selected sound's EDIT menu parameters* to the variation button.
SETUP	Store all EDIT menu parameters, all sound section panel settings, and EQ section settings to a SETUP memory.
POWERON	Store all EDIT menu parameters, all sound section panel settings, and EQ section settings as the default.

* Common parameters are not stored to SOUND memory. For more information about common parameters, please refer to page 38.

1 Storing a SOUND

This function will store the selected sound's EDIT menu parameters to the variation button, thus overwriting the existing preset sound.

1. Entering the STORE screen

Press the STORE button.

The LED indicator for the STORE button will turn ON, and the store selection screen will be shown in the LCD display.



2. Selecting the Store Sound function

Press the F1 button (SOUND) to select the Store Sound function, then press the F4 button (EXEC).

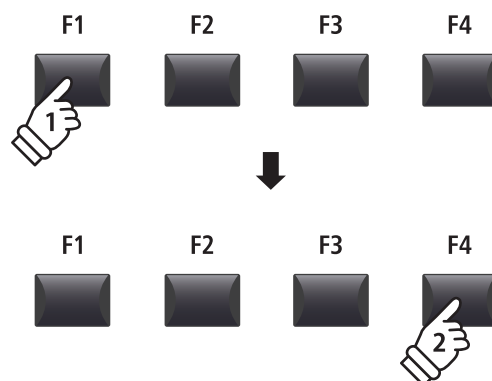

The Store Sound confirmation screen will be shown in the LCD display.



3. Confirming the Store Sound operation

Press the F2 button (YES) to confirm the Store Sound operation, or the F3 button (NO) to return to the store selection screen.

* The existing sound will be overwritten with the adjusted sound.

* The +/YES and -/NO buttons can also be used to confirm or cancel the store operation.

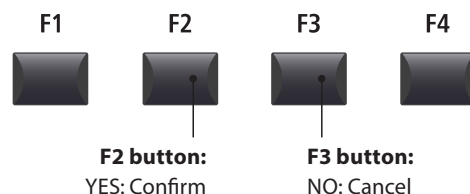

2 Storing a SETUP

This function will store all the EDIT menu parameters for the MAIN and SUB zones, panel button and knob states, and EQ settings to one of the MP7SE's 256 SETUP memories.

1. Entering the STORE screen

Press the STORE button.

The LED indicator for the STORE button will turn ON, and the store selection screen will be shown in the LCD display.

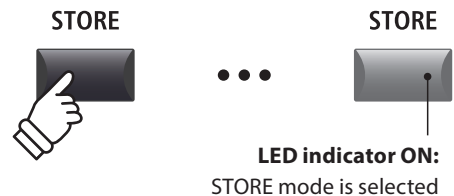

2. Selecting the Store Setup function

Press the F2 button (SETUP) to select the Store Setup function, then press the F4 button (EXEC).

The Store Setup screen will be shown in the LCD display.

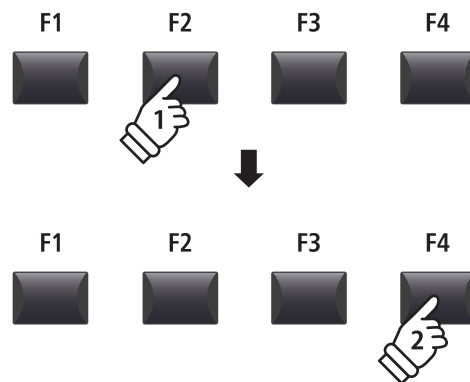

3. Naming the SETUP, selecting the SETUP memory

Turn control knobs A and B to move the cursor position and select the characters for the SETUP name.

Press the SETUP memory buttons to select the memory location for the new SETUP.



Press the F4 function button (EXEC).

The Store Setup confirmation screen will be shown in the LCD display.

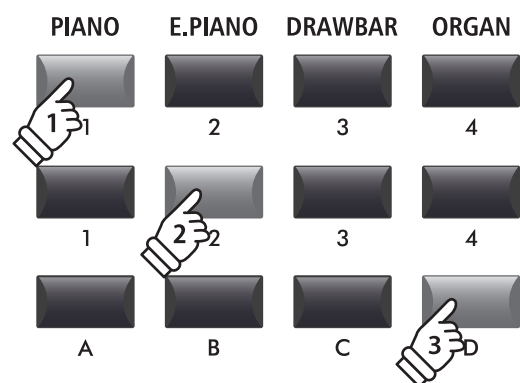

Example: To select SETUP memory 1-2D, press 'PIANO' category button, the '2' sub-category button, and the 'D' variation button.

4. Confirming the Store Setup operation

Press the F2 button (YES) to confirm the Store Setup operation, or the F3 button (NO) to return to the previous screen.

- * The existing SETUP memory will be overwritten with the new SETUP.
- * The +/YES and -/NO buttons can also be used to confirm or cancel the store operation.
- * When the SETUP has been stored and the SETUP button has been turned OFF, the panel settings will return to the POWERON state.

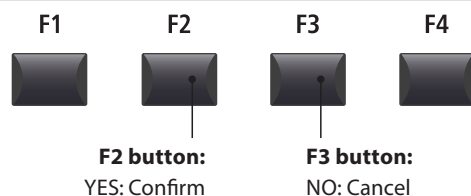

Overview of the STORE Button

3 Storing POWERON settings

This function will store the EQ setting and current state (Zone ON/OFF, selected sound) of all four zones to the MP7SE's default POWERON memory.

* Please note that only the selected SOUND position (e.g. SK Concert Grand) will be stored to POWERON memory, not the individual EDIT menu settings (e.g. String Resonance) of that SOUND.

1. Entering the STORE screen

Press the STORE button.

The LED indicator for the STORE button will turn ON, and the store selection screen will be shown in the LCD display.

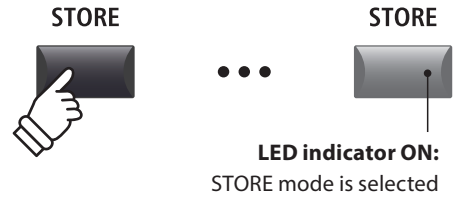

2. Selecting the Store PowerOn function

Press the F3 function button (PWRON) to select the Store PowerOn function, then press the F4 button (EXEC).



The Store PowerOn confirmation screen will be shown in the LCD display.

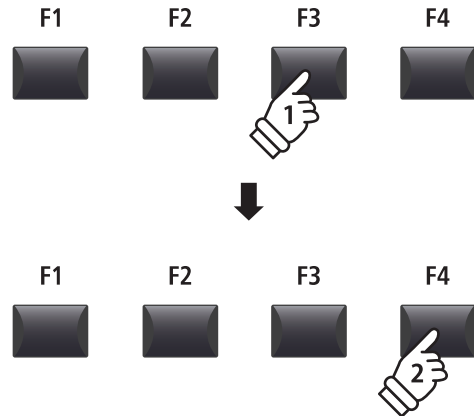
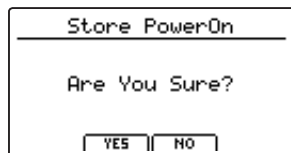

3. Confirming the Store PowerOn operation

Press the F2 button (YES) to confirm the Store PowerOn operation, or the F3 (NO) button to return to the previous screen.

* The existing POWERON memory will be overwritten.

* The +/YES and -/NO buttons can also be used to confirm or cancel the store operation.

* Please note that only the selected SOUND position (e.g. SK Concert Grand) will be stored to POWERON memory, not the individual EDIT menu settings (e.g. String Resonance) of that SOUND.

In order to memorise EDIT menu settings for a SOUND, please use the Store SOUND function. (see page 64)

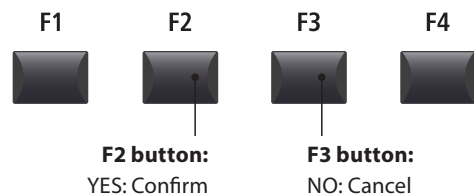

SETUP Memories

The MP7SE's SETUP memories allow the entire instrument configuration, including selected sounds, section volume levels, parameter settings, and EQ adjustments, etc. to be stored and recalled immediately at the touch of a button. SETUPS are arranged in an 8x8x4 configuration, allowing for a total of 256 individual memories.

This page explains how to select SETUP mode and recall and edit a SETUP memory.

Selecting SETUP mode

Press the SETUP button to select SETUP mode.

The LED indicator for the SETUP button will turn on to indicate that SETUP mode is selected.

The LED indicators for the currently selected SETUP memory buttons will also turn on, and the name of the SETUP memory will be shown in the LCD display.



- * The previously selected SETUP memory will be recalled automatically.
- * To check which sounds are assigned to each zone, press and hold the desired F1~F4 function button.

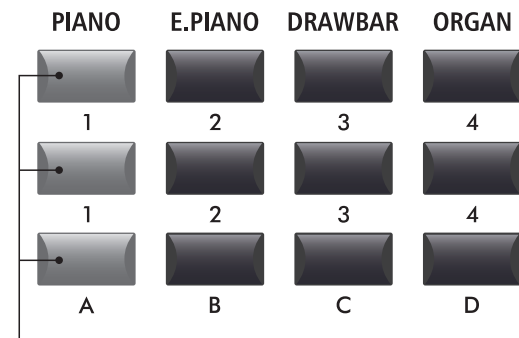
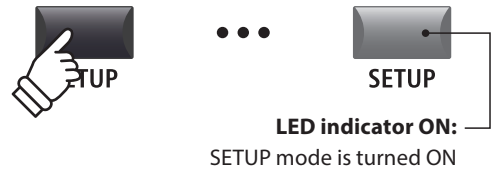

LED indicator ON:
Selected SETUP buttons

Selecting SETUPS

While SETUP mode is turned ON:

Press the SETUP memory buttons to select the desired SETUP memory.



- * In order to prevent abrupt 'breaks' in sound, the selected SETUP will not be applied immediately (i.e. when the button is pushed), but with the next key press. This allows subsequent SETUPS to be selected while the notes of the existing SETUP are held/sustained, resulting in a smooth transition between songs/sequences etc.

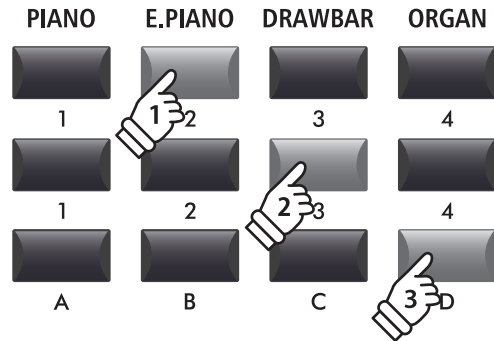

Example: To select SETUP memory 2-3D, press 'E.PIANO' category button, the '3' sub-category button, and the 'D' variation button.

Editing SETUPS

While SETUP mode is turned ON:

Press the EDIT buttons to edit the selected SETUP memory.

The LED indicator for the SETUP button will start to flash, to indicate that the SETUP memory is being edited.

In addition, the LED indicators for the SOUND and sound selection buttons will also turn on, to indicate which sound is assigned to the currently selected zone.

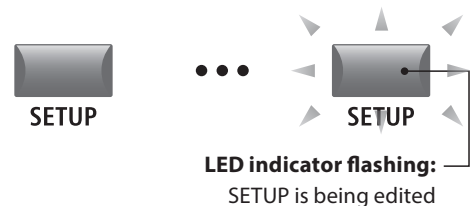

Overview of the Recorder

The MP7SE's Recorder features convenient functions to record and playback performances from the instrument's internal memory or a connected USB memory device. The characteristics of each method are outlined below.

MP7SE Recorder characteristics

	Song Recorder (Internal Memory)	Audio Recorder (USB Memory)
Stored/saved format	SMF (MIDI)	MP3/WAV (audio)
Maximum song length	90,000 notes	Depends on device capacity
Maximum no. of songs	10 songs	Depends on device capacity
Example applications	Sketching ideas, recording finished performances, remixing and further editing on a computer.	Emailing to friends, burning to audio CD, etc.
Playback methods	Playback songs on MP7SE and other MIDI devices	Playback songs on MP7SE and audio players etc.
Adjustable tempo	Yes, before and during playback	No
Overdubbing	No	Yes, unlimited overdubs
Conversion options	Can be converted to MP3/WAV	Cannot be converted to SMF (MIDI)

Turning Recorder mode ON or OFF

Press the RECORDER section's ON/OFF button to turn Recorder mode ON or OFF.

The LED indicator for the RECORDER section's ON/OFF button will turn ON or OFF accordingly.

When Recorder mode is turned ON, the recorder screen will be shown in the LCD display.

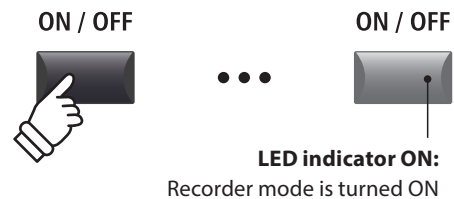

Selecting the Recorder mode

Press the F1 function button to alternate between the Internal Song Recorder and the USB Audio Recorder functions.

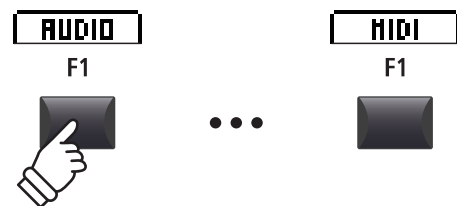
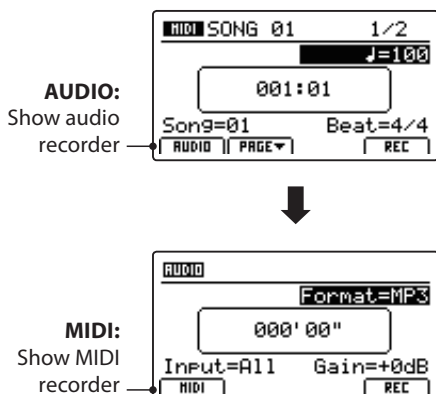

* If a USB memory device is connected when Recorder mode is turned ON, the USB Audio Recorder function will be selected automatically.

* If a USB memory device is not connected when Recorder mode is turned ON, the Internal Song Recorder function will be selected automatically.

USB Functions

Additional USB functions to delete and rename files stored on USB memory devices can be found in the USB Menu. For information about USB functions, please refer to page 99.

Song Recorder (Internal memory)

The Song Recorder function allows up to 10 different songs to be recorded, stored in internal memory, and played back at the touch of a button. Once recorded, songs can be saved to USB memory in Standard MIDI File (SMF) format, or converted to MP3/WAV audio files.

1 Recording a song

1. Turning the Recorder mode ON

Press the RECORDER section's ON/OFF button to turn Recorder mode ON.

The LED indicator for the RECORDER section's ON/OFF button will turn ON, and the MIDI recorder screen will be shown in the LCD display.



If a USB memory device is connected, press the F1 button (MIDI) to select the MIDI recorder function.

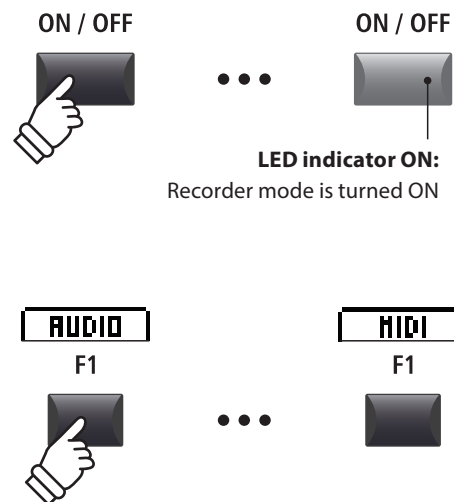

2. Selecting the song memory, adjusting tempo/beat

Turn control knob C to select the song memory to be used for the new recording.

* There are 10 internal song recorder memories.

* If the selected song memory already contains recording data, it will be erased automatically when the new song is recorded.

If recording with the metronome or a drum rhythm:

Turn control knobs B and D to adjust the tempo and beat (time signature) or drum rhythm used for the new recording.

* For more information about recording with the metronome or drum rhythms, please refer to page 97.

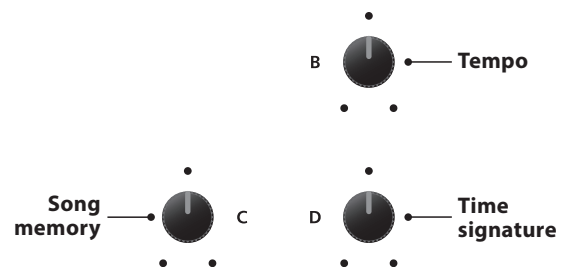

3. Starting the song recorder (standby mode)

Press the ● recorder control button.

The LED indicator for the ● button will start to flash, to indicate that the recorder is in standby mode.

* The F4 function button (REC) can also be used to engage standby mode.

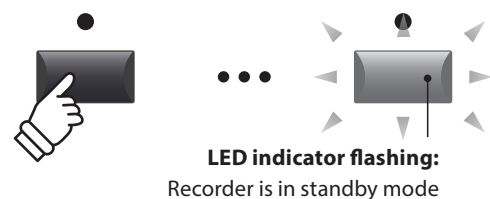
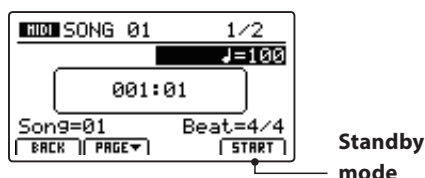

1 Recording a song (cont.)

4. Starting the song recorder (recording)

Press a key on the keyboard.

The LED indicators for the ● and ▶/■ buttons will turn ON, the bar/beat counter shown in the centre of the LCD will begin to increase, and recording will start.

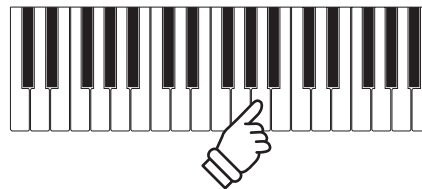
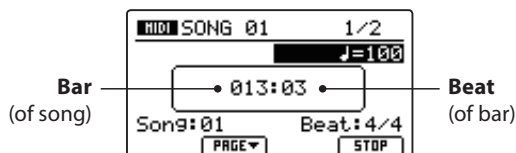

* Recording can also be started by pressing the ▶/■ button. This allows a rest period or empty bar to be inserted at the beginning of the song.

* The metronome can be enabled before recording to assist with timing etc. When enabled, a one bar count-in will be added before recording begins.

5. Stopping the song recorder

Press the ▶/■ recorder control button.

The LED indicators for the ● and ▶/■ buttons will turn OFF, and recording will stop.

* The F4 function button (STOP) can also be used to stop recording.

After a brief pause, the MIDI player screen will be shown in the LCD display.

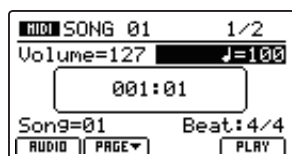

* The maximum recording capacity is approximately 90,000 notes, with button and pedal presses also counted as one note.

* If the maximum recording capacity is reached during recording, the recorder will stop automatically.

* To prevent data loss, avoid turning the power OFF while the MP7SE is saving internal recorder songs.

* Recorder songs will remain in memory after the power is turned OFF.

For information about playing the recorded song, please refer to page 71.

2 Playing back a song

This function is used to playback recorder songs stored in internal memory. To playback a song immediately after recording, start this process from step 3.

1. Turning the Recorder mode ON

Press the RECORDER section's ON/OFF button to turn Recorder mode ON.

The LED indicator for the RECORDER section's ON/OFF button will turn ON, and the MIDI recorder screen will be shown in the LCD display.



If a USB memory device is connected, press the F1 button (MIDI) to select the MIDI recorder function.

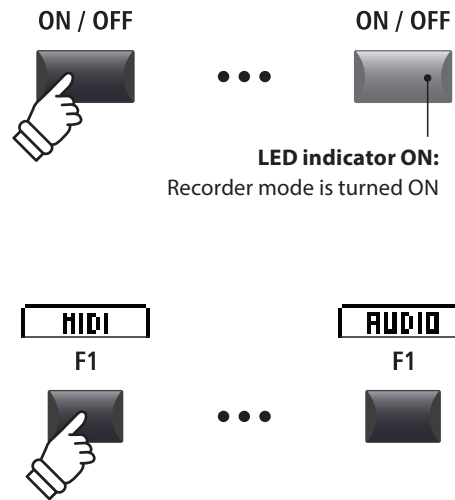

2. Selecting the song to playback

Turn control knob C to select the song memory to be played back.

* Song selection is not possible during playback.



3. Starting song playback

Press the ▶/■ recorder control button.

The LED indicator for the ▶/■ button will turn ON, and the selected song will start to play.

* The F4 function button (PLAY) can also be used to start song playback.

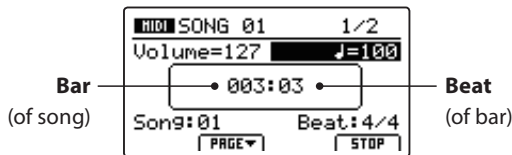

■ Adjusting playback volume and tempo

Turn control knobs A and B to adjust the playback volume and tempo of the song.

* The playback volume and tempo of the song can be adjusted both before and during playback.



Song Recorder (Internal memory)

■ Moving the playback position (seek)

Press the ◀◀ or ▶▶ recorder control buttons to move the playing position of the song backward and forward in single bar increments.

* The playback position can be moved both before and during playback.

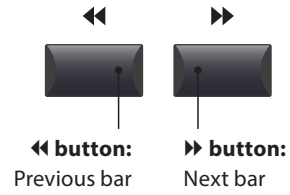

4. Stopping song playback

While a song is playing:

Press the ▶/■ recorder control button.

The LED indicator for the ▶/■ button will turn OFF, and song playback will stop.

* The F4 function button (STOP) can also be used to stop song playback.

Press the ▶/■ button again to continue playback from the stopped position, or the ◀◀ button to reset the playback position to the beginning of the song.

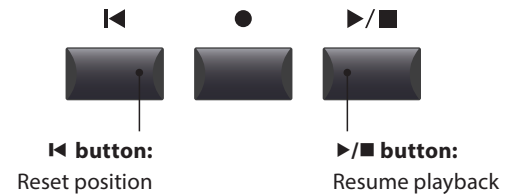
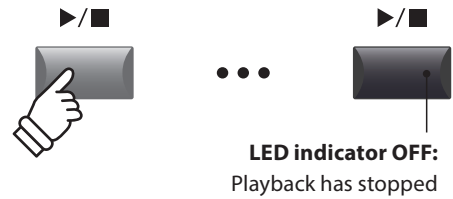

■ A-B Repeat function

The A-B Repeat function allows one section of a song to be repeated continuously (looped). This function can be activated both before and during song playback.

Press the A↔B recorder control button once to set the start point of the loop.

The LED indicator for the A↔B button will start to flash.

Press the A↔B button again to set the end point of the loop.

The LED indicator for the A↔B button will turn ON and the specified section will repeat continuously.

Press the A↔B button once again to cancel the loop.

The LED indicator for the A↔B button will turn OFF and normal playback will resume.

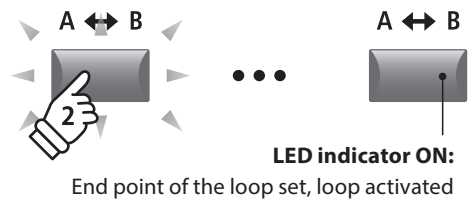
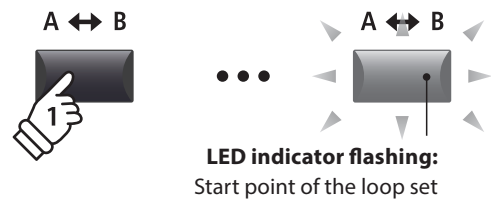

■ Chain Play mode

Chain Play mode allows all recorder songs stored in memory to be played continuously, in sequence.

Press and hold the ▶/■ recorder control button.

The Chain Play icon will be shown in the LCD display, and the recorder songs will start to play continuously, in sequence.



3 Saving a song as an SMF file

This function is used to save recorder songs to a USB memory device in SMF (Standard MIDI File) format.

1. Selecting the song memory

After turning Recorder mode ON, and recording a song:

Turn control knob C to select the song memory to be saved to the USB memory in SMF format.



2. Connecting a USB memory device

Connect a USB memory device to the USB to Device port.

* USB devices should be formatted to use the 'FAT' or 'FAT32' filesystems.

The USB device will be scanned, and the SAVE function will appear at the bottom of the LCD display.

* The SAVE function will appear only when the selected song memory has been recorded to.



3. Selecting the Save SMF function

Press the F3 function button (SAVE).

The Save SMF screen will be shown in the LCD display.

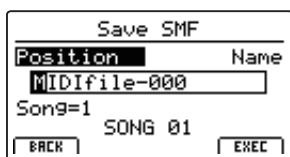
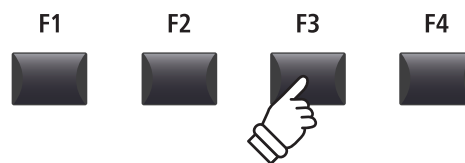

4. Entering a filename

Turn control knobs A and B to move the cursor position and select the characters for the song name.

* Saved SMF files are limited to a maximum name length of 18 characters.

* The saved SMF file will be stored in the root folder of the USB memory device. It is not possible to store the file in a different folder.

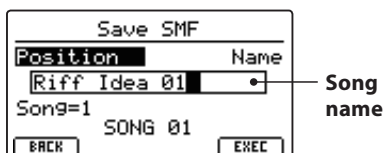

3 Saving a song as an SMF file (cont.)

5. Saving the song

Press the F4 function button (EXEC).

The Save SMF confirmation screen will be shown in the LCD display.

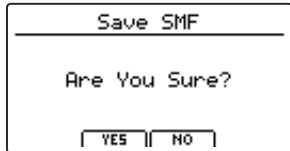

Press the F2 button (YES) to confirm the Save SMF operation, or the F3 button (NO) to return to the previous screen.

- * The +/YES and -/NO buttons can also be used to confirm or cancel the save operation.
- * To prevent data loss, avoid turning the power OFF while the MP7SE is saving files to USB memory.

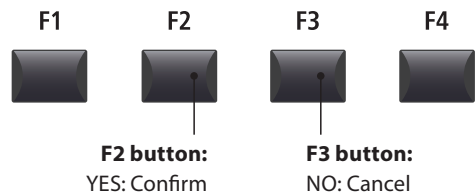

4 Loading an SMF file into memory

This function can be used to load SMF files into an empty recorder song memory.

■ Preparing the USB memory device

Prepare a selection of SMF MIDI files, copying the data to a USB memory device.



1. Selecting an empty song memory

After turning Recorder mode ON:

Turn control knob C to select an empty song memory.



2. Connecting a USB memory device

Connect a USB memory device to the USB to Device port.

* USB devices should be formatted to use the 'FAT' or 'FAT32' filesystems.

The USB device will be scanned, and the LOAD function will appear at the bottom of the LCD display.

* The LOAD function will appear only when the selected song memory is empty. For information about erasing song memories, please refer to page 77.

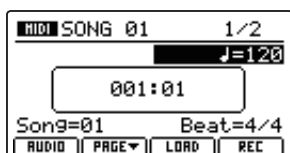

Load function

3. Selecting the Load SMF function

Press the F3 function button (LOAD).

A listing of the SMF files stored in the root folder of the USB device will be shown in the LCD display.

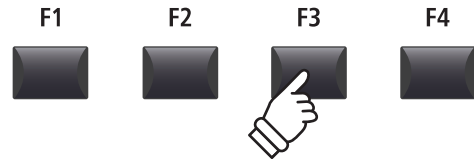

■ USB device file/folder listing screen

The MP7SE's file/folder listing screen lists relevant files and folders stored in the root of the USB device.

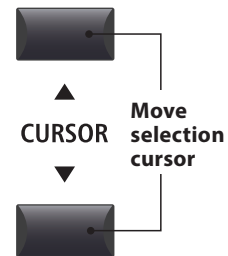

Press the CURSOR ▲▼ buttons to move the selection cursor.

* Control knob A can also be used to move the selection cursor.

Press the F4 function button (EXEC) or +/YES button to select the file or enter the selected folder.

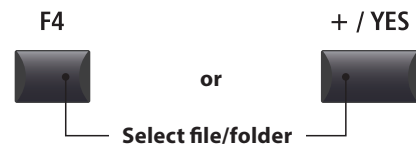

4. Selecting the SMF file to load

Press the CURSOR ▲▼ buttons to select the desired MIDI file.



Press the F4 function button (EXEC) or +/YES button.

The Load SMF screen will be shown in the LCD display.

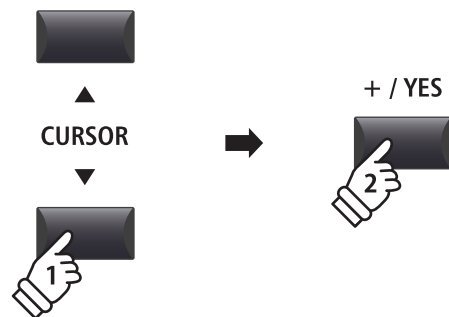
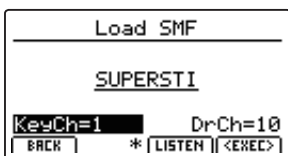

4 Loading an SMF file into memory (cont.)

5. Selecting the keyboard and drum channels

Turn control knobs C and D to specify which channels of the SMF file should be loaded into the MP7SE recorder's keyboard and drum tracks.

- * The MP7SE will attempt to detect the correct keyboard and drum tracks automatically, based on the contents of the SMF file.
- * When loading an SMF file created by the MP7SE, the drum track will be turned OFF.

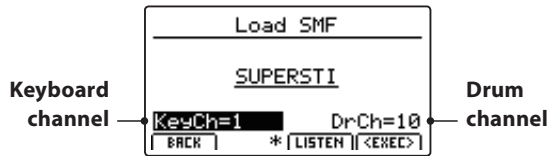

Press the F3 function button (LISTEN) to audition the current channel settings.

Press the F4 function button (EXEC) to load the selected SMF file into the song memory.

The Load SMF confirmation screen will be shown in the LCD display.

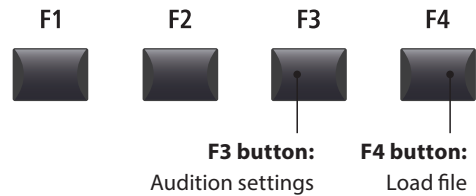

6. Confirming the Load SMF operation

Press the F2 button (YES) to confirm the Load SMF operation, or the F3 (NO) button to return to the previous screen.

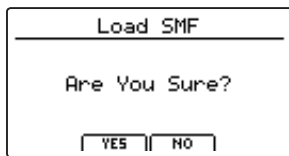

- * The +/YES and -/NO buttons can also be used to confirm or cancel the load SMF operation.

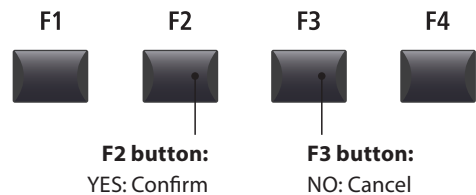

7. Playing the loaded SMF file

After loading the SMF file, the recorder screen will be shown in the LCD display.

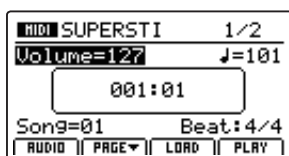

For more information about playing the loaded MIDI file, please refer to page 71.

5 Erasing a song

This function is used to erase songs that have been recorded incorrectly, or are simply no longer required.

1. Selecting the song to erase

After turning Recorder mode ON and recording a song:

Turn control knob C to select the song memory to be erased.



* To erase all recorder songs, use the Reset Recorder function in the Reset category of the SYSTEM menu (page 117).

2. Showing the additional recorder functions

Press the F2 function button (PAGE).

An additional page of recorder functions will be shown in the LCD display.

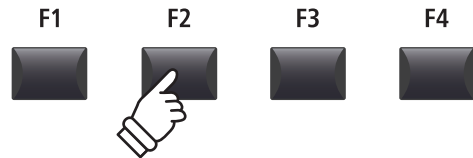
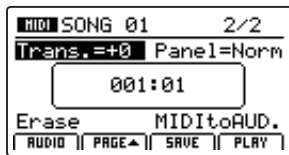

* The CURSOR ▲▼ buttons can also be used to alternate between pages.

3. Selecting the Erase Song function

Turn control knob C to highlight the Erase Song function.



* The CURSOR buttons can also be used to move the selection cursor.

Press the +/YES button to select the Erase Song function.

The Erase Song confirmation screen will be shown in the LCD display.



* It is also possible to select the Erase Song function at any time by pressing the ● and ►/■ recorder control buttons simultaneously.

4. Confirming the Erase Song operation

Press the F2 button (YES) to confirm the Erase Song operation, or the F3 (NO) button to return to the previous screen.

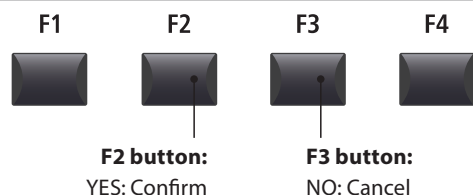
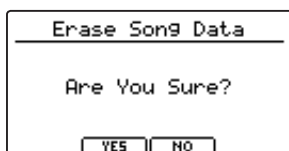

* The +/YES and -/NO buttons can also be used to confirm or cancel the Erase Song operation.

6 Song Transpose

This parameter allows the playback pitch of songs stored in memory to be raised or lowered in semi-tone steps. This may be useful when wishing to transpose a loaded SMF file into another key.

■ Changing the song transpose value

Press the F2 function button (PAGE▼) to show the second page of recorder functions.

Turn control knob A to change the song transpose value.

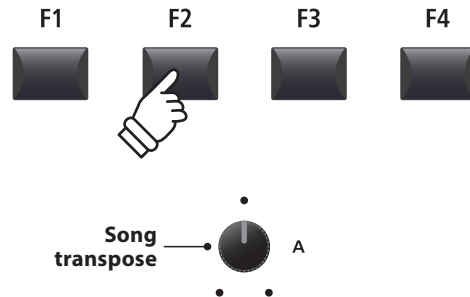

* The Song Transpose value can be adjusted within the range of -12 ~ +12.

7 Panel Mode

This parameter determines whether or not changes made to the panel during recording will be replicated when a song is played back, thus influencing the current keyboard settings.

■ Panel Mode types

Panel Mode	Description
Normal (default)	Panel settings will not change during song playback, and will not influence the current keyboard settings.
Play	Panel settings will change during song playback, and will also influence the current keyboard settings.

	Normal panel mode	Play panel mode
Advantages	Keyboard settings are independent of recorder song.	All functions (including EFX) are played back perfectly.
Disadvantages	Some functions (e.g. EFX) are not played back perfectly.	Keyboard settings are dependent on recorder song.

■ Changing the panel mode type

Press the F2 function button (PAGE▼) to show the second page of recorder functions.

Turn control knob B to change the panel mode type.

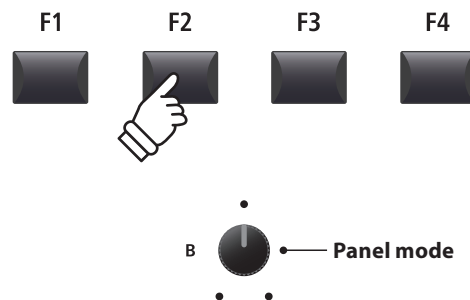
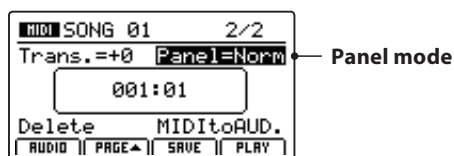

8 MIDI to Audio

For information about the MIDI to Audio function, please refer to page 90.

9 SMF Direct Play

This function allows 16-track SMF files to be played directly from USB memory.

1. Selecting the Load SMF function

After preparing and connecting the USB memory:

Press the F3 function button (LOAD).

A listing of the SMF files stored in the root folder of the USB device will be shown in the LCD display.

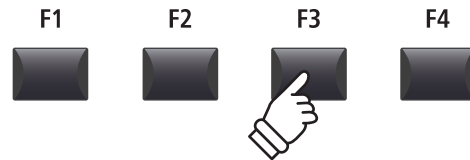

2. Selecting the SMF file to play

Press the CURSOR ▲▼ buttons to select the desired MIDI file.



Press the F2 or F3 function buttons (DIRECT PLAY).

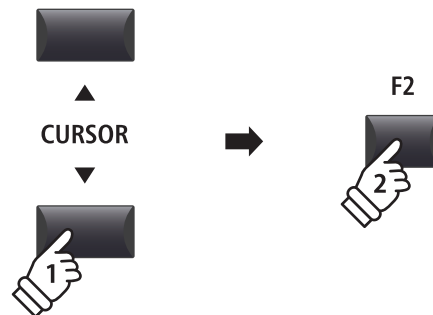

3. Playing the selected SMF file

After selecting the Direct Play function, the player screen will be shown in the LCD display.

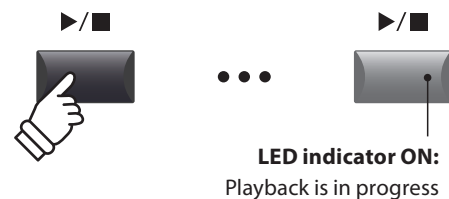

For more information about playing the loaded MIDI file and using the 'Chain Play' feature, please refer to page 71.

* Press the F1 function button (INT) to exit the SMF Direct Play function and return to the internal song player screen.

Changing the song transpose value

Press the F2 function button (PAGE▼) to show the second page of playback functions.

Turn control knob A to change the song transpose value.

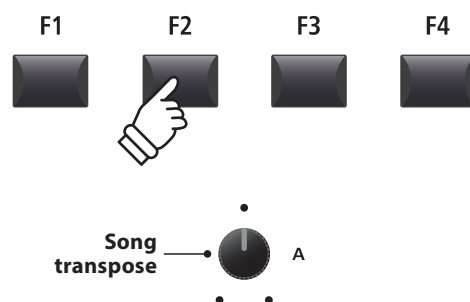

* The Song Transpose value can be adjusted within the range of -12 ~ +12.

SMF Mixer

The SMF Mixer screen allows the volume levels of all 16 tracks of the loaded SMF file to be adjusted or muted.

1. Selecting the SMF Mixer

After loading an SMF file:

Press the F2 function button (PAGE▼) to show the second page of playback functions.

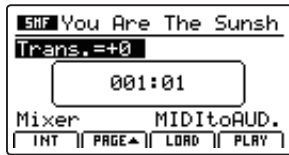
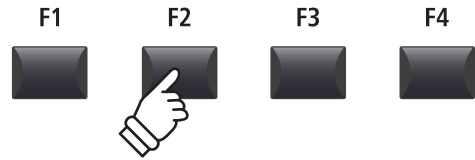

Turn control knob C to highlight the Mixer function.



Mixer function highlighted

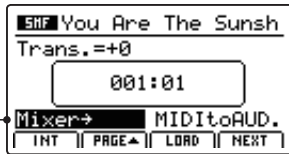

* The CURSOR buttons can also be used to move the selection cursor.

Press the +/YES button to select the Mixer function.

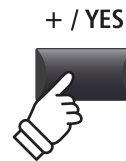

The SMF Mixer screen will be shown in the LCD display.

SMF Mixer screen

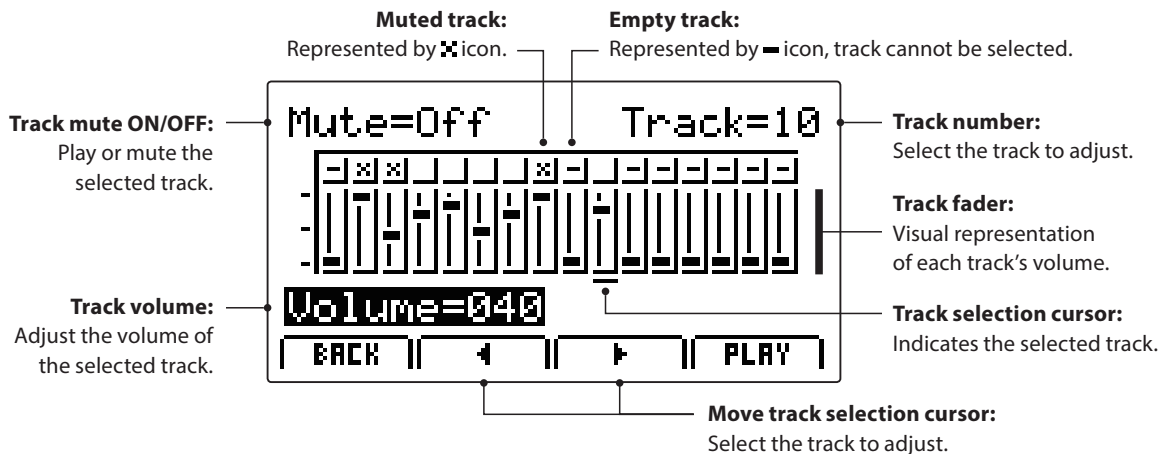

2. Selecting tracks, muting and adjusting volume

After selecting the Mixer function:

Turn control knob B to select the track for adjustment, and control knob C to adjust the volume level.



Turn control knob A to Mute/Play the selected track.



* The F2 or F3 function buttons (◀ and ▶) can also be used to select tracks.

Audio Record/Playback (USB memory)

1 Recording an audio file

The MP7SE is also capable of recording performances (including LINE IN input audio) as digital audio – saving the data to a USB memory device in either MP3 or WAV format. This useful function allows professional quality recordings to be produced directly on the instrument – without the need for additional sound equipment – then emailed to band members, listened to away from the instrument, or edited and remixed further using an audio workstation.

Audio Recorder format specifications

Audio Format	Specifications	Bitrate
MP3	44.1 kHz, 16 bit, Stereo	192 kbit/s (fixed)
WAV	44.1 kHz, 16 bit, Stereo	1,411 kbit/s (uncompressed)

* MPEG Layer-3 audio coding technology licensed from Fraunhofer IIS and Thomson.
MP3 codec is Copyright (c) 1995-2007, SPIRIT

1. Connecting a USB memory device

Connect a USB memory device to the USB to Device port.

* USB devices should be formatted to use the 'FAT' or 'FAT32' filesystems.



The USB device will be scanned.

2. Turning the Recorder mode ON

Press the RECORDER section's ON/OFF button to turn Recorder mode ON.

The LED indicator for the RECORDER section's ON/OFF button will turn ON, and the Audio recorder screen will be shown in the LCD display.

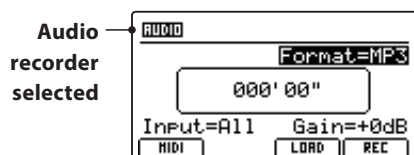
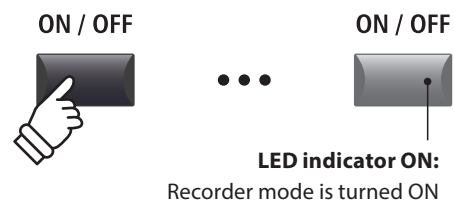

* If the MIDI recorder screen is shown, press the F1 function button (AUDIO) to select the Audio recorder.

Selecting the audio recorder file format

Turn control knob B to select the desired audio recorder format.

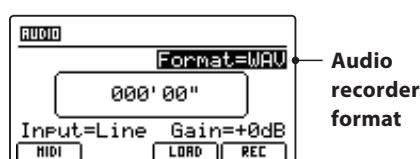

* MP3 audio files require less storage space than WAV audio files.

* A 1 GB USB memory device can store over 12 hours of MP3 audio data.

1 Recording an audio file (cont.)

■ Selecting the audio recorder input, adjusting gain level

Turn control knob C to select the desired audio recorder input.

Turn control knob D to adjust the gain level of the recorder.

Increasing the audio recorder gain level parameter may be useful when recording quieter passages.

Input	Description
All	Record the keyboard sound and the LINE IN sound.
Line	Record the LINE IN sound only.

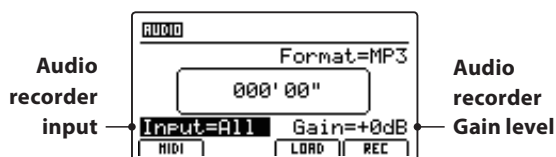

* The gain level can be set within the range of -18 dB ~ +18 dB.

3. Starting the audio recorder (standby)

Press the ● recorder control button.

The LED indicator for the ● button will start to flash, to indicate that the recorder is in standby mode.

* The F4 function button (REC) can also be used to engage standby mode.

* Depending on the USB memory device connected, there may be a brief delay before standby mode is engaged.

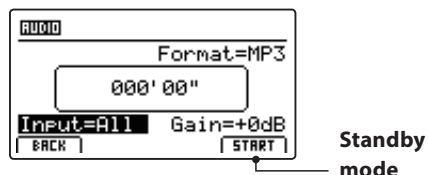
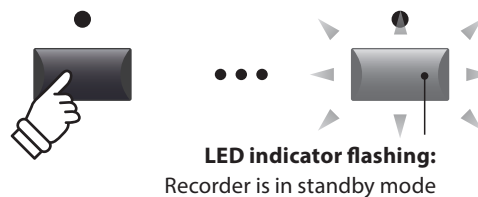

4. Starting the audio recorder (record)

Press a key on the keyboard.

The LED indicators for the ● and ▶/■ buttons will turn ON, the time counter shown in the centre of the LCD will begin to increase, and recording will start.

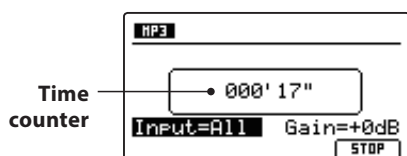
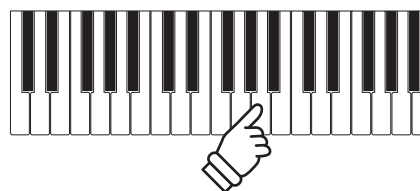

* Recording can also be started by pressing the ▶/■ button. This allows a rest period or empty bar to be inserted at the beginning of the song.

* The metronome can be enabled before recording to assist with timing etc. When enabled, a one bar count-in will be added before recording begins.

5. Stopping the audio recorder, auditioning the recording

Press the ▶/■ recorder control button.

The LED indicators for the ● and ▶/■ buttons will turn OFF, and recording will stop.

* The F4 function button (STOP) can also be used to stop recording.

After a brief pause, the Audio player screen will be shown in the LCD display.

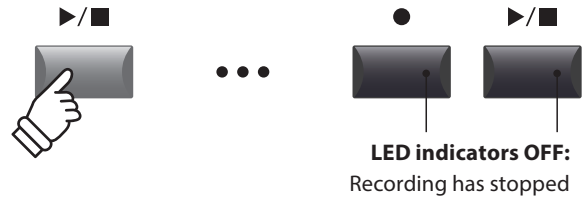

* Press the ● and ▶/■ recorder control buttons simultaneously to erase the recorded audio file from memory.

Press the F4 function button (PLAY) to audition the recording before saving.



6. Selecting the save function, entering the audio file name

Press the F3 function button (SAVE).

The save audio screen will be shown in the LCD display.

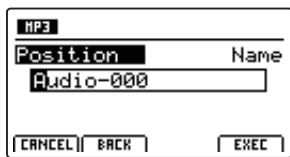

Turn control knobs A and B to move the cursor position and select the characters for the audio file name.

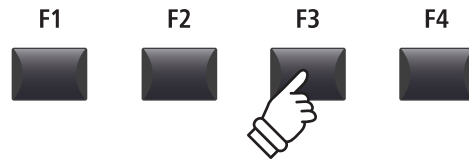
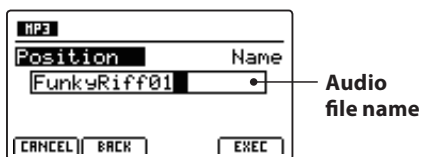

* Saved audio files are limited to a maximum name length of 18 characters.
* The saved audio file will be stored in the root folder of the USB memory device. It is not possible to store the file in a different folder.

7. Saving the audio file

Press the F4 function button (EXEC).

The save audio confirmation screen will be shown in the LCD display.

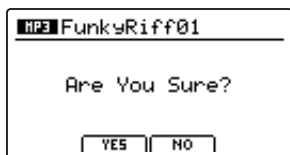

Press the F2 button (YES) to confirm the save audio operation, or the F3 button (NO) to return to the previous screen.

* The +/YES and -/NO buttons can also be used to confirm or cancel the save operation.

* To prevent data loss, avoid turning the power OFF while the MP7SE is saving files to USB memory.

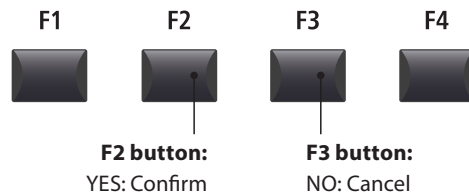

2 Playing an audio file

The MP7SE is also capable of playing MP3 and WAV audio files stored on a USB memory device. This function allows performing musicians to play along with professional backing tracks, or conveniently learn the chords or melody for a new piece.

■ Audio Player supported format specifications

Audio Format	Specifications	Bitrate
MP3	32 kHz/44.1 kHz/48 kHz, Mono/Stereo	8-320 kbit/s (fixed & variable)
WAV	32 kHz/44.1 kHz/48 kHz, Mono/Stereo, 8 bit/16 bit	-

* MPEG Layer-3 audio coding technology licensed from Fraunhofer IIS and Thomson. MP3 codec is Copyright (c) 1995-2007, SPIRIT

■ Preparing the USB memory device

Prepare a selection of MP3 or WAV audio files, copying the data to a USB memory device.

* USB devices should be formatted to use the 'FAT' or 'FAT32' filesystems.



1. Connecting a USB memory device

Connect the USB memory device to the USB to Device port.

The USB device will be scanned.



2. Turning the Recorder mode ON

Press the RECORDER section's ON/OFF button to turn Recorder mode ON.

The LED indicator for the RECORDER section's ON/OFF button will turn ON, and the Audio recorder screen will be shown in the LCD display.

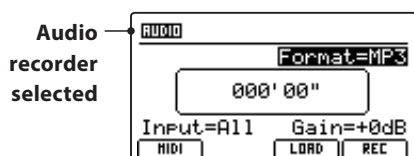
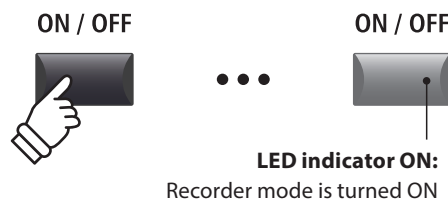

* If the MIDI recorder screen is shown, press the F1 function button (AUDIO) to select the Audio recorder.

3. Selecting the Load Audio function

Press the F3 function button (LOAD).

A listing of the MP3 files stored in the root folder of the USB device will be shown in the LCD display.

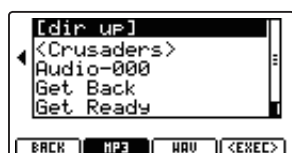
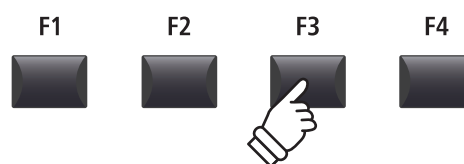

■ USB device file/folder listing screen

The MP7SE's file/folder listing screen lists relevant files and folders stored in the root of the USB device.



Press the CURSOR ▲▼ buttons to move the selection cursor.

* Control knob A can also be used to move the selection cursor.

Press the F3 or F2 function buttons to alternate between showing WAV or MP3 format audio files.

* By default, MP3 files will be shown.

Press the F4 function button (EXEC) or +/YES button to select the file or enter the selected folder.

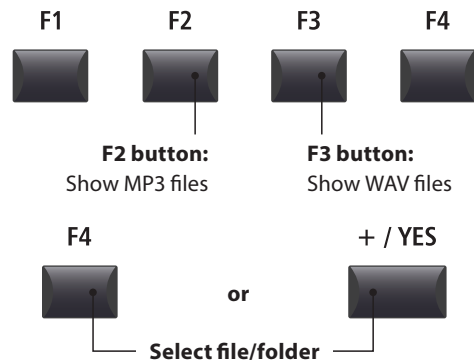
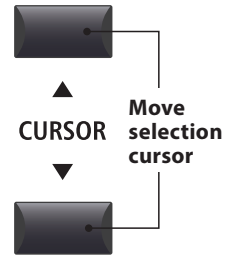

4. Selecting the audio file to load

Press the CURSOR ▲▼ buttons to select the desired audio file.



Press the F4 function button (EXEC) or +/YES button.

The audio player screen will be shown in the LCD display.

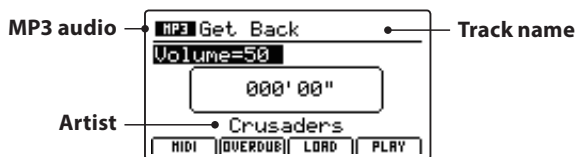

* If available, the audio file's metadata (ID3 tags etc.) will also be shown.

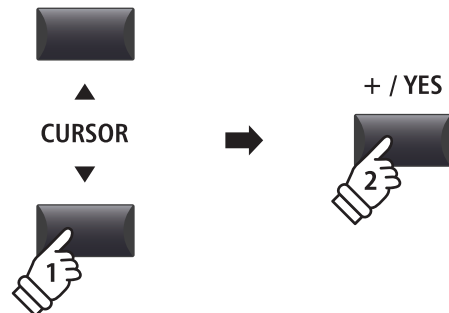

5. Starting audio file playback

Press the ►/■ recorder control button.

The LED indicator for the ►/■ button will turn ON, and the selected song will start to play.

* The F4 function button (PLAY) can also be used to start song playback.



■ Moving the playback position (seek)

Press the ◀◀ or ▶▶ recorder control buttons to rewind or fast-forward the playing position of the audio file.

* The playback position can be moved both before and during playback.

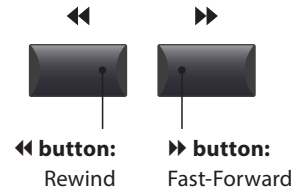

6. Stopping audio file playback

While an audio file is playing:

Press the ▶/■ recorder control button.

The LED indicator for the ▶/■ button will turn OFF, and audio file playback will stop.

Press the ▶/■ button again to continue playback from the stopped position, or the ◀◀ button to reset the playback position to the beginning of the audio file.

* The F4 function button (STOP) can also be used to reset audio playback.

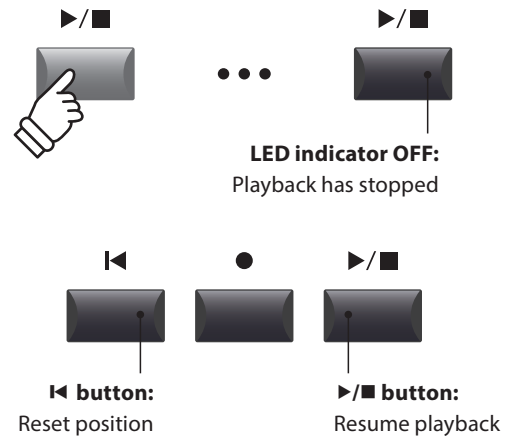

■ A-B Repeat function

The A-B Repeat function allows one section of an audio file to be repeated continuously (looped). This function can be activated both before and during audio file playback.

Press the A↔B recorder control button once to set the start point of the loop.

The LED indicator for the A↔B button will start to flash.

Press the A↔B button again to set the end point of the loop.

The LED indicator for the A↔B button will turn ON and the specified section will repeat continuously.

Press the A↔B button once again to cancel the loop.

The LED indicator for the A↔B button will turn OFF and normal playback will resume.

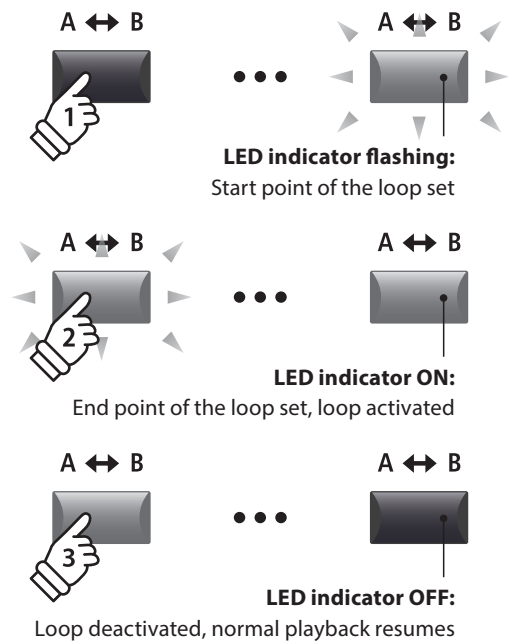

■ Chain Play mode

Chain Play mode allows all audio files stored in a folder to be played continuously, in sequence.

Press and hold the ▶/■ recorder control button.

The Chain Play icon will be shown in the LCD display, and the audio files will start to play continuously, in sequence.



3 Overdubbing an audio file

The overdub function adds supplementary recording(s) to an existing audio file, facilitating simple multi-track recordings to be produced directly on the instrument.

Each overdub is recorded to a temporary file (i.e. the original audio file is not modified), allowing an unlimited number of overdubs that to be made before eventually saving the final recording.

1. Connecting a USB memory device

Connect the USB memory device to the USB to Device port.

The USB device will be scanned.



2. Turning the Recorder mode ON

Press the RECORDER section's ON/OFF button to turn Recorder mode ON.

The LED indicator for the RECORDER section's ON/OFF button will turn ON, and the Audio recorder screen will be shown in the LCD display.

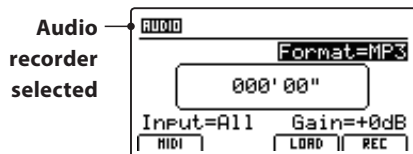
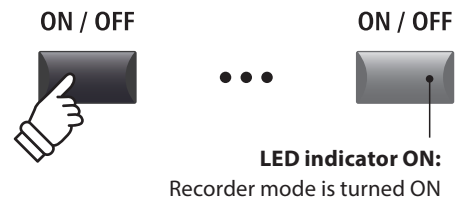

* If the MIDI recorder screen is shown, press the F1 function button (AUDIO) to select the Audio recorder.

3. Selecting the Load Audio function

Press the F3 function button (LOAD).

A listing of the MP3 files stored in the root folder of the USB device will be shown in the LCD display.

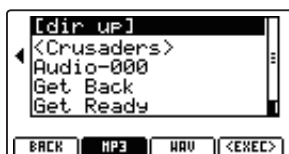
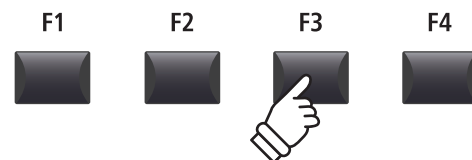

4. Selecting the audio file to load

Press the CURSOR ▲▼ buttons to select the desired audio file.



Press the F4 function button (EXEC) or +/YES button.

The audio player screen will be shown in the LCD display.

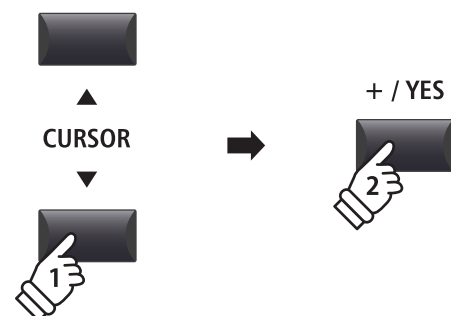

3 Overdubbing an audio file (cont.)

5. Selecting the overdub function and file format

Press the F2 function button (OVERDUB).

The overdub file format selection screen will be shown in the LCD display.

Turn control knob B to select the desired overdub file format, and control knob A to adjust the volume of the source audio.

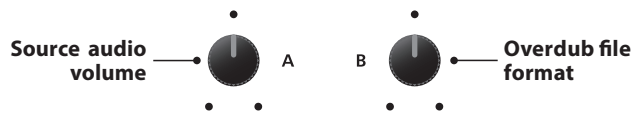
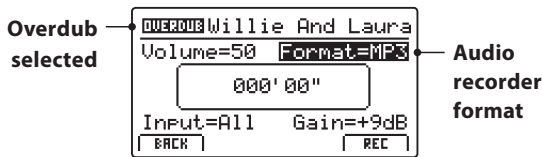
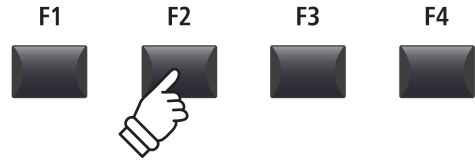

- * MP3 audio files require less storage space than WAV audio files.
- * A 1 GB USB memory device can store over 12 hours of MP3 audio data.

Selecting the audio recorder input, adjusting gain level

Turn control knob C to select the desired audio recorder input.

Turn control knob D to adjust the gain level of the overdub.

Increasing the audio recorder gain level parameter may be useful when recording quieter passages.

Input	Description
All	Record the keyboard sound and the LINE IN sound.
Line	Record the LINE IN sound only.

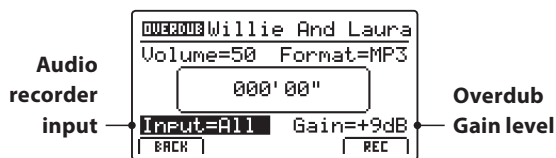

- * The gain level can be set within the range of -18 dB ~ +18 dB.

6. Starting the overdub (standby)

Press the ● recorder control button.

The LED indicator for the ● button will start to flash, to indicate that the recorder is in standby mode.

- * The F4 function button (REC) can also be used to engage standby mode.
- * Depending on the USB memory device connected, there may be a brief delay before standby mode is engaged.

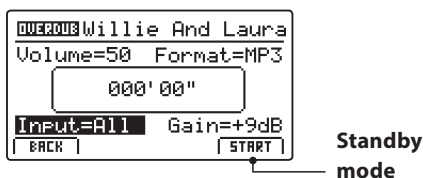
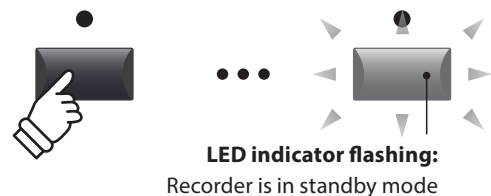

Recorder

7. Starting the overdub (record)

Press a key on the keyboard.

The LED indicators for the ● and ▶/■ buttons will turn ON, the time counter shown in the centre of the LCD will be to increase, and overdubbing will start.

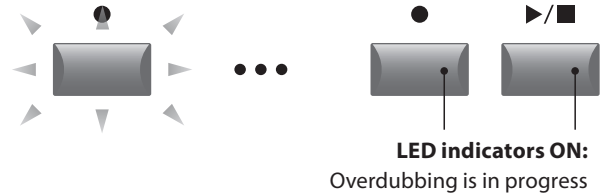
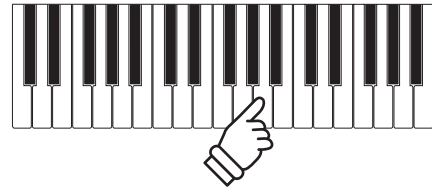
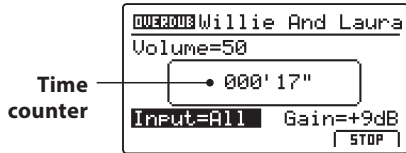

- * Overdubbing can also be started by pressing the ▶/■ button. This allows a rest period or empty bar to be inserted at the beginning of the song.
- * The metronome can be enabled before overdubbing to assist with timing etc. When enabled, a one bar count-in will be added before overdubbing begins.

8. Stopping and auditioning the overdub

Press the ▶/■ recorder control button.

The LED indicators for the ● and ▶/■ buttons will turn OFF, and overdubbing will stop.

- * The F4 function button (STOP) can also be used to stop overdubbing.

After a brief pause, the Audio player screen will be shown in the LCD display.



Audition overdub

Press the F4 function button (PLAY) to audition the overdub before saving.

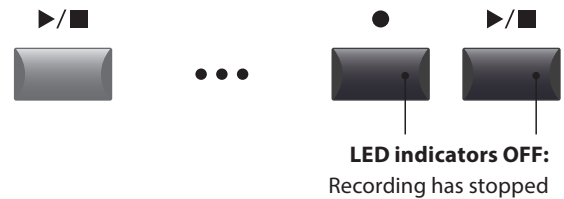

- * Press the ● and ▶/■ recorder control buttons simultaneously to erase the overdubbed audio file from memory.



9. Selecting the save function, entering the audio file name

Press the F3 function button (SAVE).

The save audio screen will be shown in the LCD display.

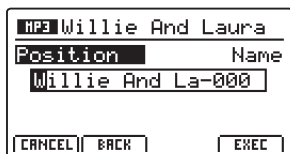

Turn control knobs A and B to move the cursor position and select the characters for the audio file name.

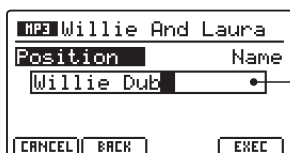

Audio file name

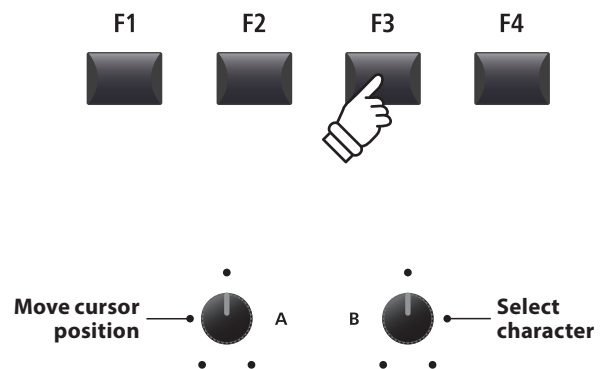

- * Saved audio files are limited to a maximum name length of 18 characters.
- * The saved audio file will be stored in the root folder of the USB memory device. It is not possible to store the file in a different folder.

10. Saving the dubbed file

Press the F4 function button (EXEC).

The save audio confirmation screen will be shown in the LCD display.

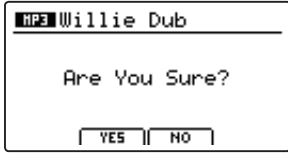

Press the F2 button (YES) to confirm the save audio operation, or the F3 button (NO) to return to the previous screen.

* The +/YES and -/NO buttons can also be used to confirm or cancel the save operation.

* To prevent data loss, avoid turning the power OFF while the MP7SE is saving files to USB memory.

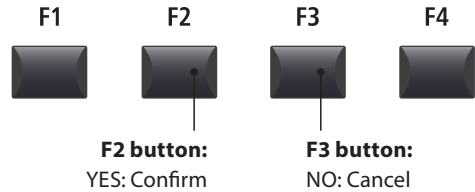

4 MIDI to Audio

This function allows recorder songs stored in internal memory to be played back and saved (converted) as an audio file to a USB device in either MP3 or WAV format.

1. Connecting a USB memory device

Connect the USB memory device to the USB to Device port.

* USB devices should be formatted to use the 'FAT' or 'FAT32' filesystems.

The USB device will be scanned.



2. Selecting the MIDI to Audio function

After selecting the MIDI recorder and recording a song:

Press the F2 function button (PAGE▼) to show the additional MIDI recorder functions.

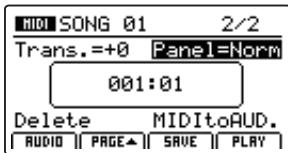

Turn control knob D to highlight the MIDI to Audio function.

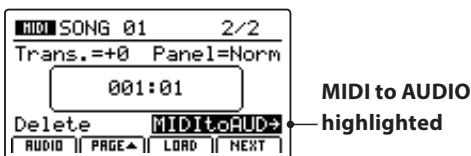

* The CURSOR buttons can also be used to move the selection cursor.

Press the +/YES button to select the MIDI to Audio function.

The MIDI to Audio screen will be shown in the LCD display.

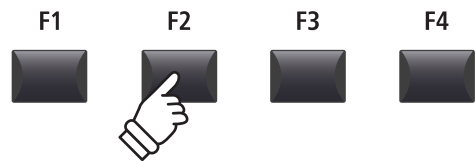

+ / YES



3. Selecting the MIDI to Audio file format

Turn control knob B to select the desired MIDI to Audio file format, and control knob A to adjust the volume of the song playback.

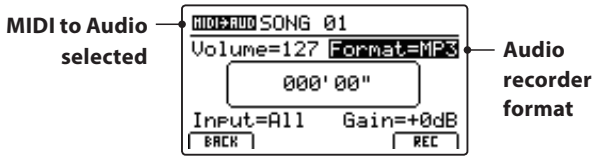
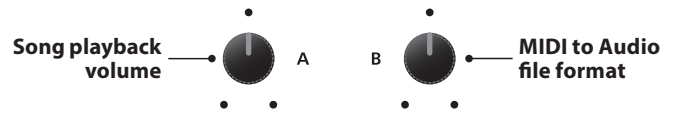

- * MP3 audio files require less storage space than WAV audio files.
- * A 1 GB USB memory device can store over 12 hours of MP3 audio data.

Selecting the audio recorder input, adjusting gain level

Turn control knob C to select the desired audio recorder input.

Input	Description
All	Record the keyboard sound and the LINE IN sound.
Line	Record the LINE IN sound only.

Turn control knob D to adjust the gain level of the MIDI to Audio conversion/recording.

Increasing the audio recorder gain level parameter may be useful when recording quieter passages.

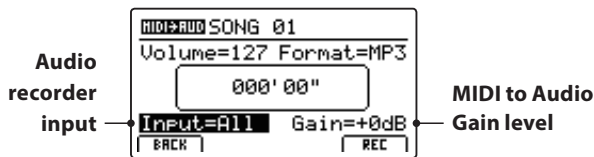

- * The gain level can be set within the range of -18 dB ~ +18 dB.

4. Starting the conversion (standby)

Press the ● recorder control button.

The LED indicator for the ● button will start to flash, to indicate that the recorder is in standby mode.

- * The F4 function button (REC) can also be used to engage standby mode.
- * Depending on the USB memory device connected, there may be a brief delay before standby mode is engaged.

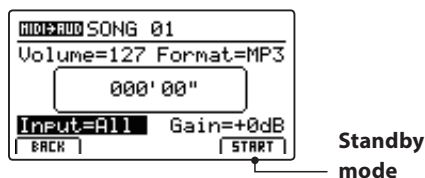
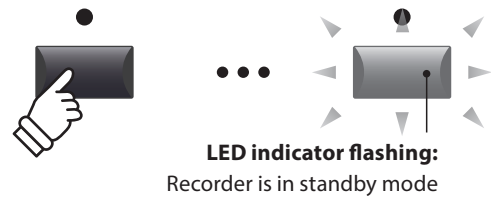

5. Starting the conversion (record)

Press the ▶/■ recorder control button.

The LED indicators for the ● and ▶/■ buttons will turn ON, the time counter shown in the centre of the LCD will begin to increase, and the conversion will start.

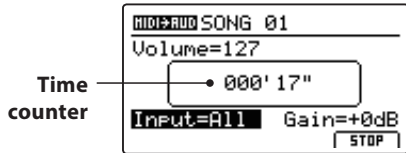

Time counter

Conversion will stop automatically when the end of the recorder song is reached.

* The ▶/■ button or F4 function button (STOP) can also be used to stop the conversion before the end of the song.

The LED indicators for the ● and ▶/■ buttons will turn OFF, and the conversion will stop.

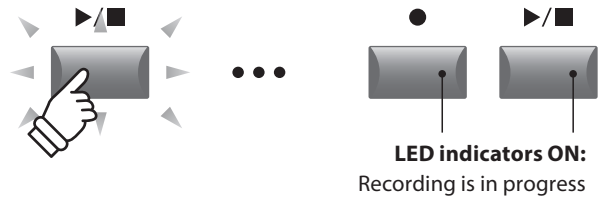

* Conversion can also be started by pressing the F4 function button (START).

* Notes played on the keyboard will also be recorded to the audio file..

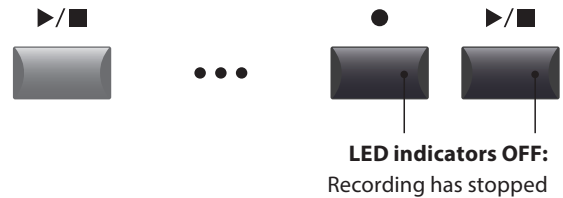

6. Selecting the save function, entering the audio file name

Press the F3 function button (SAVE).

The save audio screen will be shown in the LCD display.

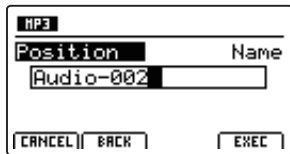

Turn control knobs A and B to move the cursor position and select the characters for the audio file name.

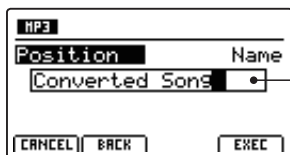

Audio file name

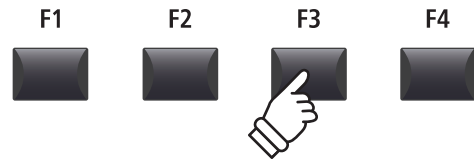

* Saved audio files are limited to a maximum name length of 18 characters.

* The saved audio file will be stored in the root folder of the USB memory device. It is not possible to store the file in a different folder.

7. Saving the converted audio file

Press the F4 function button (EXEC).

The save confirmation screen will be shown in the LCD display.

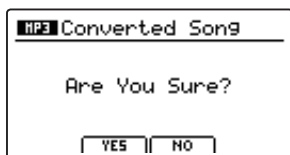

Press the F2 button (YES) to confirm the save audio operation, or the F3 button (NO) to return to the previous screen.

* The +/YES and -/NO buttons can also be used to confirm or cancel the save operation.

* To prevent data loss, avoid turning the power OFF while the MP7SE is saving files to USB memory.

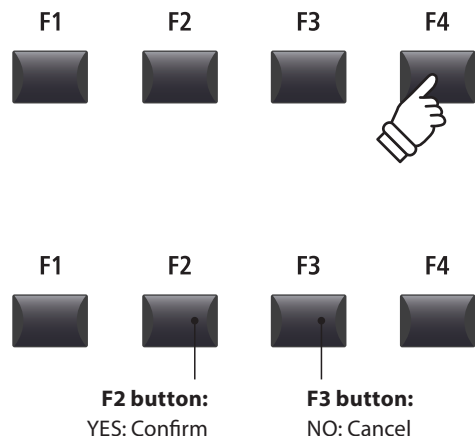

Metronome

The Metronome function provides a steady beat to aid practicing the piano at a consistent tempo. In addition to regular metronome beats in various time signatures, the MP7SE also features a selection of drum rhythms to accompany most playing styles and musical genres.

1 Click mode

In Click mode, the metronome function provides a simple click track in a number of different time signatures.

■ Activating the metronome function

Press the METRONOME button.

The LED indicator for the METRONOME button will turn ON to indicate that the metronome function is in use, and the Metronome screen will be shown in the LCD display.

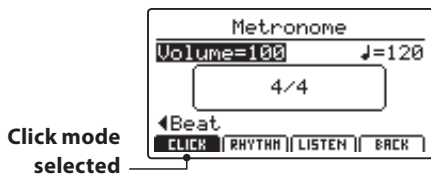
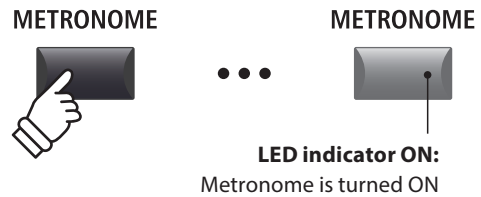

* The metronome will be set to Click mode by default.

■ Starting and Stopping the metronome

Press the F3 function button (LISTEN)

The LISTEN icon will become highlighted and the metronome will start counting a 4/4 beat at 120 bpm (beats per minute).

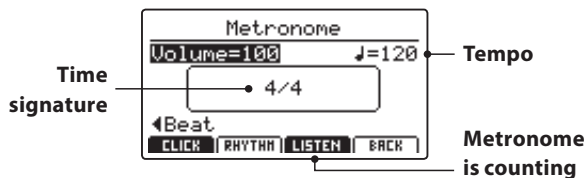
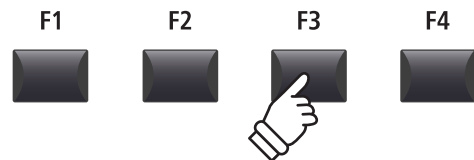

Press the F3 function button again to stop the metronome.

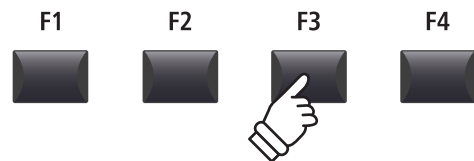

■ Adjusting the Metronome volume, tempo, and time signature (beat)

Turn control knobs A and B to adjust the metronome volume and tempo, and knob C to change the time signature (beat).

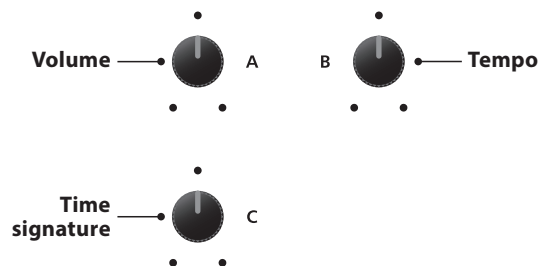
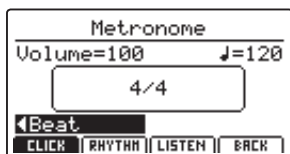

* The metronome tempo can be adjusted within the range of 30-300 bpm (60-600 bpm for eighth note time signatures).

* There are ten different types of beat/time signature available: 1/4, 2/4, 3/4, 4/4, 5/4, 3/8, 6/8, 7/8, 9/8, and 12/8.

* Preferred metronome settings can be saved to a SETUP or POWERON memory for immediate recall.

1 Click mode (cont.)

■ Returning to the previous screen (BACK function)

While the metronome is counting:

Press the F4 function button (BACK) to return to the previous screen without stopping or deactivating the metronome.



Press and hold the METRONOME button again to show the Metronome screen in the LCD display.

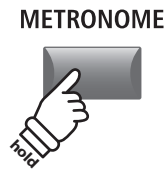

2 Rhythm mode

In Rhythm mode, the metronome function provides a more musically inspiring drum track. There are 100 different drum patterns available, grouped into 13 categories.

* For a full listing of available drum patterns, please refer to page 96.

■ Activating the metronome function

Press the METRONOME button.

The LED indicator for the METRONOME button will turn ON to indicate that the metronome function is in use, and the Metronome screen will be shown in the LCD display.

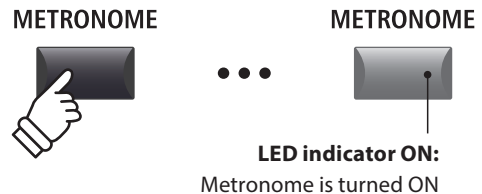
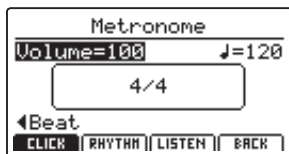

* The metronome will be set to Click mode by default.

■ Selecting Rhythm mode

Press the F2 function button (RHYTHM)

The RHYTHM icon will become highlighted, and the currently selected drum rhythm category and variation will be shown in the LCD display.

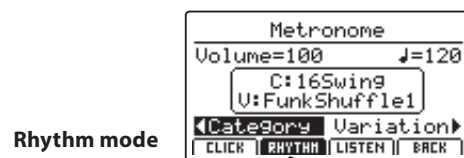
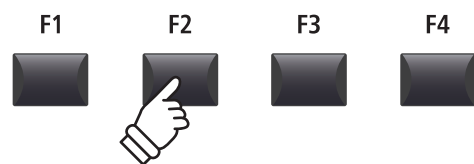

Rhythm mode selected

Starting and Stopping the drum rhythm

Press the F3 function button (LISTEN)

The LISTEN icon will become highlighted and the currently selected drum rhythm category and variation will start to play.

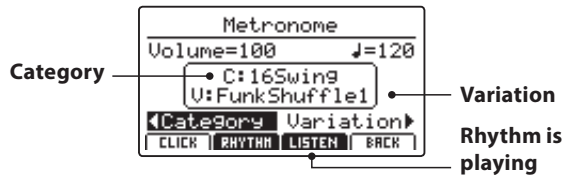

Press the F3 function button again to stop the drum rhythm.

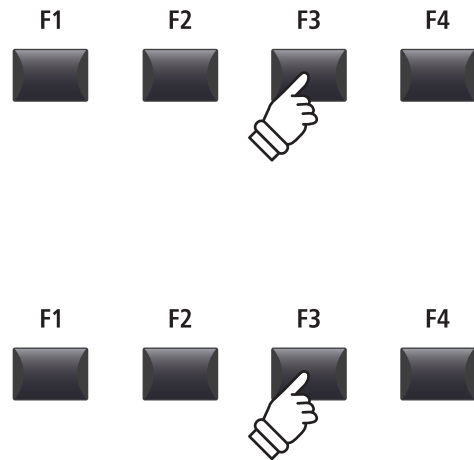

Adjusting the drum rhythm volume, tempo, category, and variation

Turn control knobs A and B to adjust the drum rhythm volume and tempo.

Turn control knobs C and D to select the drum rhythm category and variation.

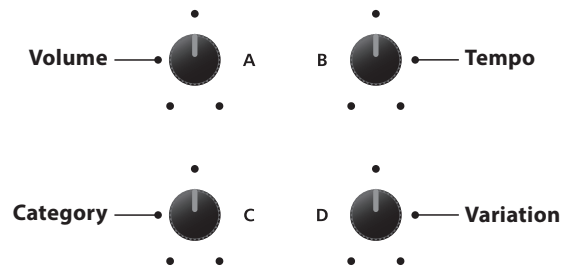
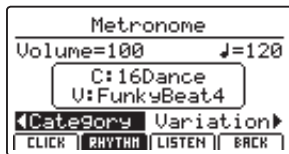

* The metronome tempo can be adjusted within the range of 30-300 bpm.

* For a full listing of available drum patterns, please refer to page 96.

* Preferred drum rhythm settings can be saved to a SETUP or POWERON memory for immediate recall.

Returning to the previous screen (BACK function)

While the drum rhythm is playing:

Press the F4 function button (BACK) to return to the previous screen without stopping or deactivating the metronome.

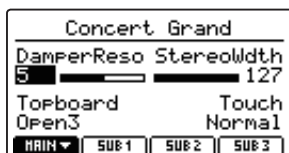

Press and hold the METRONOME button again to show the Metronome screen in the LCD display.

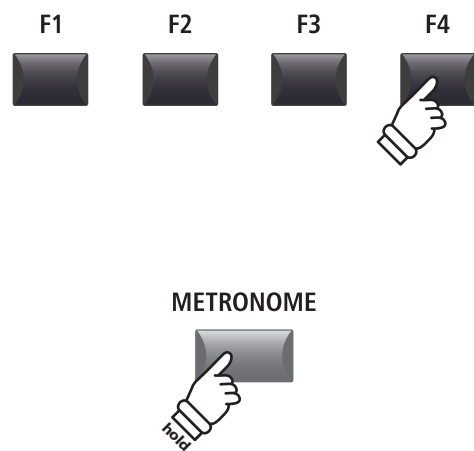

2 Rhythm mode (cont.)

■ Drum rhythm categories and variations

16 Swing	
1	Funk Shuffle 1
2	Funk Shuffle 2
3	Hip Hop 1
4	Hip Hop 2
5	Hip Hop 3
6	Hip Hop 4
7	16 Shuffle 1
8	16 Shuffle 2
9	16 Shuffle 3

16 Funk	
10	Funky Beat 1
11	Funky Beat 2
12	Funky Beat 3
13	Funk 1
14	Funk 2
15	Funk 3

16 Straight	
16	Jazz Funk
17	16 Beat 1
18	16 Beat 2
19	16 Beat 3
20	16 Beat 4
21	Ride Beat 4
22	Rim Beat
23	Roll Beat
24	Light Ride 1
25	Dixie Rock

16 Latin	
26	Surdo Samba
27	Latin Groove
28	Light Samba
29	Songo
30	Samba
31	Merenge

16 Dance	
32	Funky Beat 4
33	16 Beat 5
34	Disco 1
35	Disco 2
36	Techno 1
37	Techno 2
38	Techno 3
39	Heavy Techno

16 Ballad	
40	Ballad 1
41	Ballad 2
42	Ballad 3
43	Ballad 4
44	Ballad 5
45	Light Ride 2
46	Electro Pop 1
47	Electro Pop 2
48	16 Shuffle 4

8 Ballad	
49	Slow Jam
50	50's Triplet
51	R&B Triplet

8 Straight	
52	8 Beat 1
53	8 Beat 2
54	Smooth Beat
55	Pop 1
56	Pop 2
57	Ride Beat 1
58	Ride Beat 2
59	Ride Beat 3
60	Slip Beat

8 Rock	
61	Jazz Rock
62	8 Beat 3
63	Rock Beat 1
64	Rock Beat 2
65	Rock Beat 3
66	Rock Beat 4
67	Blues/Rock
68	Heavy Beat
69	Hard Rock
70	Surf Rock
71	R&B

8 Swing	
72	Motown 1
73	Fast Shuffle
74	Motown 2
75	Country 2 Beat

Triplet	
76	Triplet Rock 1
77	Triplet Rock 2
78	Bembe
79	Rock Shuffle 1
80	Rock Shuffle 2
81	Boogie
82	Triplet 1
83	Triplet 2
84	Reggae
85	Gospel Ballad
86	Waltz

Jazz	
87	H.H. Swing
88	Ride Swing
89	Fast 4 Beat
90	Afro Cuban
91	Jazz Waltz 1
92	Jazz Waltz 2
93	5/4 Swing

8 Latin	
94	H.H. Bossa
95	Ride Bossa
96	Beguine
97	Mambo
98	Cha Cha
99	Tango
100	Habanera

3 Recording with the metronome

Recording with the metronome is a convenient way to maintain consistent timing and rhythm while playing. This is especially important when integrating recordings into a sequencer or DAW.

The explanation below uses the internal song recorder as an example, however the procedure for recording with the metronome to an MP3/WAV audio file is identical.

1. Turning the Recorder mode ON

Press the RECORDER section's ON/OFF button to turn Recorder mode ON.

The LED indicator for the RECORDER section's ON/OFF button will turn ON, and the MIDI recorder screen will be shown in the LCD display.

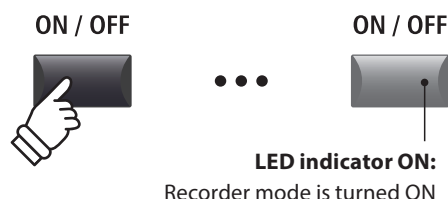

2. Activating the metronome function

Press the METRONOME button.

The LED indicator for the METRONOME button will turn ON to indicate that the metronome function is in use, and the Metronome screen will be shown in the LCD display.

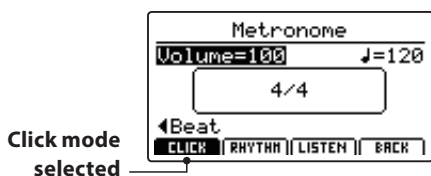
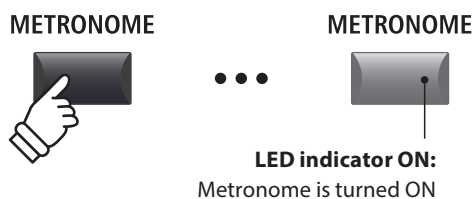

3. Adjusting the Metronome volume, tempo, and time signature (beat)

Turn control knobs A and B to adjust the metronome volume and tempo, and knob C to change the time signature (beat).

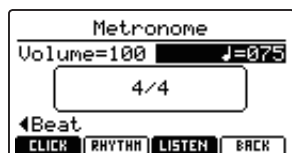
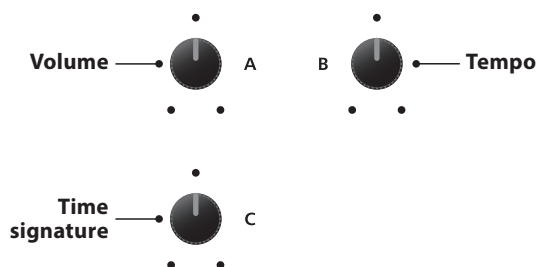

Press the F3 function button (LISTEN) to listen to the current metronome settings.

- * The metronome tempo can be adjusted within the range of 30-300 bpm (60-600 bpm for eighth note rhythms).
- * There are ten different types of beat/time signature available: 1/4, 2/4, 3/4, 4/4, 5/4, 3/8, 6/8, 7/8, 9/8, and 12/8.
- * Preferred metronome settings can be saved to a SETUP or POWERON memory for immediate recall.

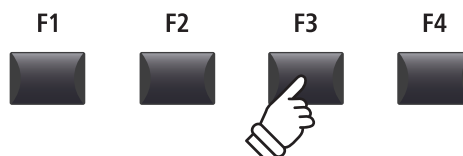

4. Returning to the Recorder function

Press the F4 function button (BACK) to return to the recorder function.

The LED indicator for the METRONOME button will remain lit, indicating that the metronome function is still activated.

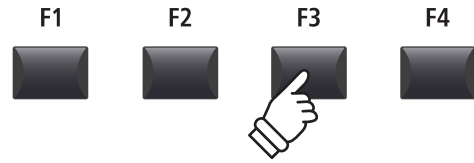

METRONOME



LED indicator remains ON:
Metronome is still activated

5. Starting the song recorder (standby mode)

Press the ● recorder control button.

The LED indicator for the ● button will start to flash, to indicate that the recorder is in standby mode.

* The F4 function button (REC) can also be used to engage standby mode.

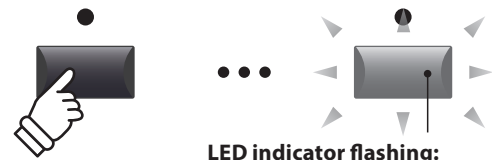

LED indicator flashing:
Recorder is in standby mode

6. Starting the song recorder (recording)

Press the ▶/■ recorder control button or F4 button (REC).

The LED indicators for the ● and ▶/■ buttons will turn ON, a one bar count-in will be played, and recording will start.

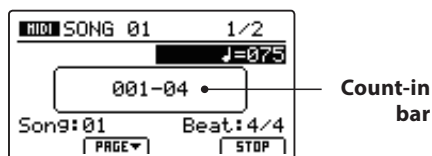

LED indicators ON:
Recording is in progress

* Recording can also be started by pressing a key on the keyboard. In this case, recording will start immediately and the one bar count-in will not be played.

* When recording with the metronome in Click mode, the metronome sound will not be heard during playback. However, when recording with the metronome in Rhythm mode, the drum pattern will be heard during playback.

7. Stopping the song recorder

Press the ▶/■ recorder control button.

The LED indicators for the ● and ▶/■ buttons will turn OFF, and recording will stop.

* The F4 function button (STOP) can also be used to stop recording.

After a brief pause, the MIDI player screen will be shown in the LCD display.

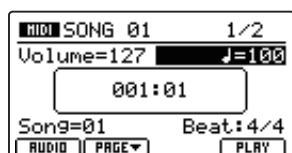

LED indicators OFF:
Recording has stopped

* The maximum recording capacity is approximately 90,000 notes, with button and pedal presses also counted as one note.

* If the maximum recording capacity is reached during recording, the recorder will stop automatically.

* Recorder songs will remain in memory after the power is turned OFF.

Overview of the USB Menu

The USB Menu contains functions to load, save, delete, and rename the various types of MP7SE data stored on a USB memory device. It is also possible to format the memory device, erasing all stored data.

MP7SE data types

Data type	Description	File extension
SOUND	A backup of a single SOUND's parameters.	.km5
SETUP	A backup of a single SETUP memory.	.km6
SMF	A standard MIDI format (SMF) song file.	.mid
Song	A MP3/WAV audio file or SMF song file.	.mp3, .wav, .mid
All Sound	A backup of all the MP7SE's stored SOUND parameters.	.km2
All Setup	A backup of all the MP7SE's SETUP memories.	.km3
All Backup	A backup of all the MP7SE's SETUP memories, SOUND parameters, and SYSTEM settings.	.km4

Entering the USB Menu

Connect a USB memory device.

* USB devices should be formatted to use the 'FAT' or 'FAT32' filesystems.

Press the USB button.

The LED indicator for the USB button will turn ON, and the USB Menu will be shown in the LCD display.

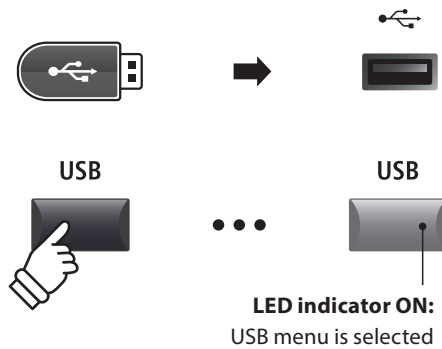

Selecting USB functions

Press the CURSOR buttons then the +/YES button or F4 function button (NEXT) to select and enter the desired category page.

Use the same control method again to select each function.

Press the -/NO or F1 function button (BACK) to return to the previous screen.

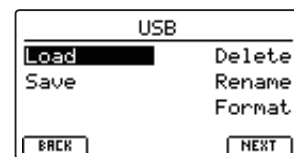

USB device file/folder listing screen

The MP7SE's file/folder listing screen lists relevant files and folders stored in the root of the USB device.

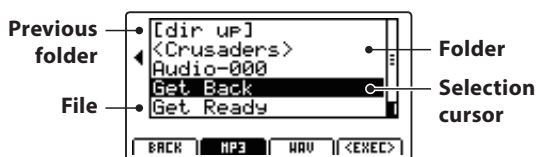

Press the CURSOR ▲▼ buttons to move the selection cursor.

* Control knob A can also be used to move the selection cursor.

Press the F4 function button (EXEC) or +/YES button to select the file or enter the selected folder.

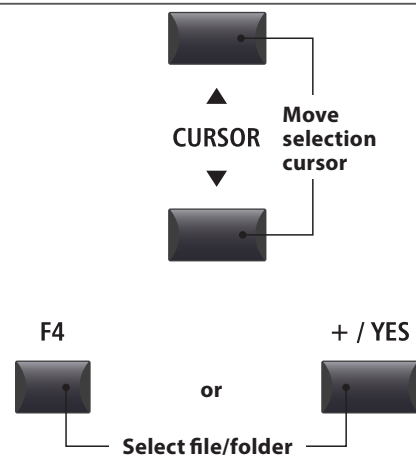

USB Menu Functions

1 Load

These functions allow data stored on a USB memory device to be loaded into the instrument's internal memory.



Load functions will overwrite the existing data stored in internal memory. Exercise caution when using these functions in order to prevent accidental data loss.

1. Load One Sound

This function loads a SOUND file stored on a USB memory, replacing the preset parameters for that specific sound.

After selecting this function, select the desired SOUND file from the file/folder listing screen.

Finally, press the F2 or F3 function buttons to confirm or cancel the load operation.

* After loading, the SOUND will be selected automatically, and all other sections will be turned OFF. SETUPs will also be turned OFF.

3. Load SMF

This function loads an SMF song file stored on a USB memory device into the MP7SE's internal song recorder memory.

After selecting this function, select the desired SMF file from the file/folder listing screen. Then use the control knobs A, C, and D to specify the destination song memory and keyboard/drum channels.



Finally, press the F2 or F3 function buttons to confirm or cancel the load operation.

* After loading, the MIDI record/playback screen will be shown in the LCD display and the destination song memory will be selected automatically.

* For more information about the song recorder, please refer to page 69.

5. Load All Setup

This function restores all SETUP memories from an All Setup file stored on a USB memory device.

After selecting this function, select the desired All Setup file from the file/folder listing screen.

Finally, press the F2 or F3 function buttons to confirm or cancel the load operation.

2. Load One Setup

This function loads a SETUP file stored on a USB memory device into one of the MP7SE's 256 SETUP memories.

After selecting this function, select the desired SETUP file from the file/folder listing screen. Then press the BANK and SETUP memory buttons to specify the destination SETUP memory.

Finally, press the F2 or F3 function buttons to confirm or cancel the load operation.

* After loading, the SETUP will be selected automatically.

4. Load All Sound

This function replaces the preset parameters for all internal sounds from an All Sound file stored on a USB memory device.

After selecting this function, select the desired All Sound file from the file/folder listing screen.

Finally, press the F2 or F3 function buttons to confirm or cancel the load operation.

6. Load All Backup

This function restores the parameters for all SETUP memories, SOUND parameters, and SYSTEM settings from an All Backup file stored on a USB memory device.

After selecting this function, select the desired All Backup file from the file/folder listing screen.

Finally, press the F2 or F3 function buttons to confirm or cancel the load operation.

2 Save

These functions allow data stored in the instrument's internal memory to be saved to a USB memory device.

1. Save One Sound

This function saves the currently selected sound's parameters to a USB memory device.

* If the selected zone is set to EXT, the MAIN zone's current sound will be saved automatically.

After selecting this function, a confirmation screen will be shown in the LCD display. Press the F4 function button (NEXT) to continue.

Enter a name for the saved SOUND file using control knobs A and B, then press the F4 function button (EXEC).

Finally, press the F2 or F3 function buttons to confirm or cancel the save operation.

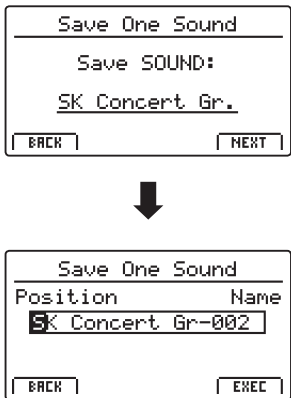

2. Save One Setup

This function saves a SETUP memory to a USB memory device.

After selecting this function, a confirmation screen will be shown in the LCD display. Press the BANK and SETUP memory buttons to specify the destination SETUP memory, then press the F4 function button (NEXT) to continue.

Enter a name for the saved SETUP file using control knobs A and B, then press the F4 function button (EXEC).

Finally, press the F2 or F3 function buttons to confirm or cancel the save operation.



3. Save SMF

This function saves an internal recorder song to a USB memory device in SMF format.

After selecting this function, the Save SMF screen will be shown in the LCD display. Select the song memory to be saved using control knob C, and enter a name for the saved SMF file using control knobs A and B, then press the F4 function button (EXEC).

Finally, press the F2 or F3 function buttons to confirm or cancel the save operation.

* For more information about the song recorder, please refer to page 69.

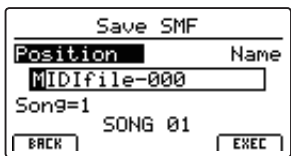

2 Save (cont.)

4. Save All Sound

This function saves the parameters for all internal sounds to a USB memory device.

After selecting this function, enter a name for the saved AllSound file using control knobs A and B, then press the F4 function button (EXEC).

5. Save All Setup

This function saves all of the SETUP memories stored in the instrument to a USB memory device.

After selecting this function, enter a name for the saved AllSetup file using control knobs A and B, then press the F4 function button (EXEC).

6. Save All Backup

This function saves the parameters for all internal sounds, all SETUP memories, and all SYSTEM settings to a USB memory device.

After selecting this function, enter a name for the saved AllBackup file using control knobs A and B, then press the F4 function button (EXEC).

3 Delete

These functions allow data stored on a USB memory device to be deleted.



Delete functions will erase data from the connected USB memory device. Exercise caution when using these functions in order to prevent accidental data loss.

1. Selecting the type of file to delete

Press the CURSOR buttons then the +/YES button or F4 function button (NEXT) to select the type of file to be deleted.

Press the -/NO or F1 function button (BACK) to return to the previous screen.

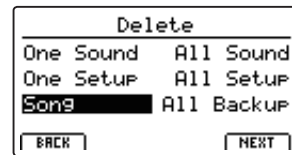

2. Selecting the file to delete

Turn control knob A or press the CURSOR buttons to move the selection cursor. Then press the +/YES button or F4 function button (EXEC) to delete the file.

Press the -/NO or F1 function button (BACK) to return to the previous screen.

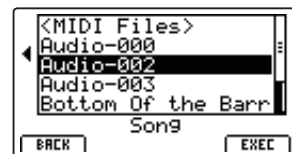

3. Confirming the file deletion

Press the F2 function button (YES) or F3 function button (NO) to confirm or cancel the delete file operation.

After deleting the file, the main USB Menu will screen will be shown in the LCD display.

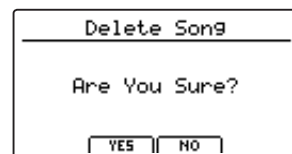

4 Rename

These functions allow data stored on a USB memory device to be renamed.

1. Selecting the type of file to rename

Press the CURSOR buttons then the +/YES button or F4 function button (NEXT) to select the type of file to be renamed.

Press the -/NO or F1 function button (BACK) to return to the previous screen.

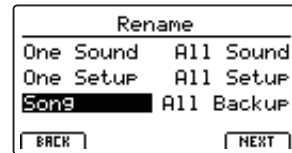

2. Selecting the file to rename

Turn control knob A or press the CURSOR buttons to move the selection cursor. Then press the +/YES button or F4 function button (EXEC) to rename the file.

Press the -/NO or F1 function button (BACK) to return to the previous screen.

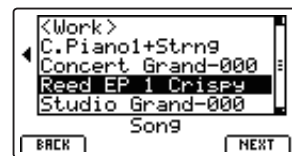

3. Renaming the file

Turn control knobs A and B to move the position of the cursor and change the character, then press F4 function button (EXEC) to rename the file.

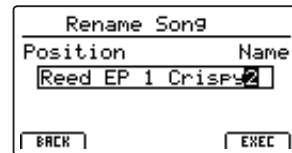

4. Confirming the file rename

Press the F2 function button (YES) or F3 function button (NO) to confirm or cancel the rename file operation.

After renaming the file, the main USB Menu will screen will be shown in the LCD display.

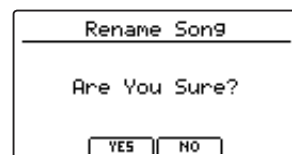

5 Format

This function allows a USB memory device to be formatted, erasing all stored data.



The Format function will erase all data stored on the connected USB memory device. Exercise caution when using this function in order to prevent accidental data loss.

1. Selecting the Format function

Press the CURSOR buttons then the +/YES button or F4 function button (NEXT) to select the format function.

Press the -/NO or F1 function button (BACK) to return to the previous screen.

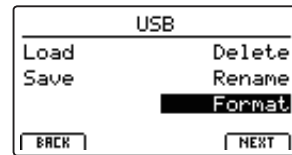

2. First confirmation prompt

The first confirmation prompt will be shown in the LCD display.

Press the +/YES button or F4 function button (EXEC) to select the proceed with the format function.

Press the -/NO or F1 function button (BACK) to return to the previous screen.

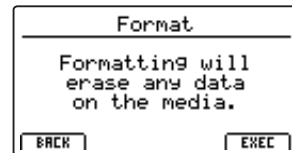

3. Final confirmation prompt

A final confirmation prompt will be shown in the LCD display.

Press the +/YES button or F4 function button (EXEC) to select the proceed with the format function.

Press the -/NO or F1 function button (BACK) to return to the previous screen.

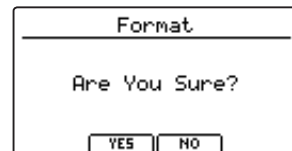

Overview of the SYSTEM Menu

The SYSTEM menu contains parameters and settings that affect the general operation of the MP7SE. These settings are grouped into six categories: Utility, Pedal, MIDI, Offset, User Edit, and Reset. SYSTEM parameters will be memorised automatically when instrument is turned OFF.

SYSTEM Menu parameters

Category	Parameters
Utility F4	System Tuning, Eff. SW Mode, Knob Action, Volume Fader Action, LCD Contrast, LCD Reverse, Input Level, Audio Output Mode, Lock SW Mode, Auto Power Off, SW1 Mode, SW2 Mode
Pedal/Mod. F5	Damper Pedal Mode, Half Pedal Adjust, FSW Pedal Mode, FSW Pedal Polarity, Modulation Wheel Curve, EXP Pedal Curve, EXP Pedal Calibrate, Right Pedal Mode, Center Pedal Mode, Left Pedal Mode
MIDI F4	System Channel, Key to MIDI, Key to USB, MIDI to MIDI, MIDI to USB, USB to MIDI, SETUP Program, SETUP Bank, SETUP Volume, SETUP Knobs, Receive Mode, Receive Channel, Program Mode
Offset F5	EQ Offset On/Off, Reverb Offset, EQ Offset Low, EQ Offset High, EQ Offset Mid1, EQ Offset Mid2
User Edit F5	User Touch Curve, User Temperament, User KeyVolume, User Stretch, User Voicing
Reset	One Sound, All Sound, One Setup, All Setup, System, Power On, Recorder, Factory

Entering the SYSTEM Menu

Press the SYSTEM button.

The LED indicator for the SYSTEM button will turn ON, and the SYSTEM Menu will be shown in the LCD display.

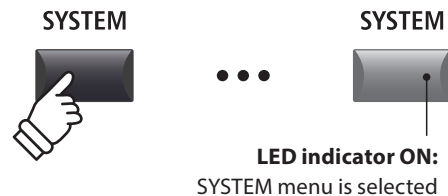
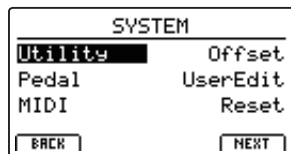

Selecting the SYSTEM parameter category

Press the CURSOR buttons to select, and then the F4 function button (NEXT) or +/YES button to enter the desired category.

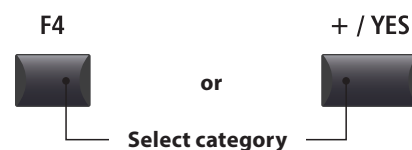

Adjusting SYSTEM parameters

Turn the four control knobs (A, B, C, D) to adjust the parameters assigned to those knob.

Parameters can also be adjusted by using the CURSOR buttons to move the selection cursor, and +/YES or -/NO buttons to increase or decrease the value of the selected parameter.

Press the F2 and F3 function buttons to cycle through the SYSTEM menu pages.

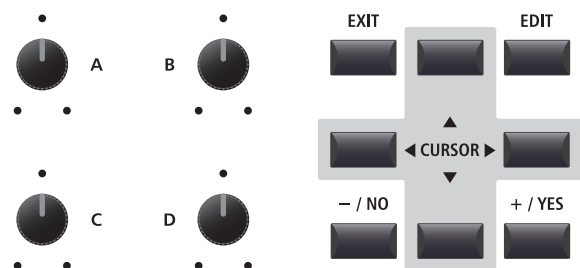

* The CURSOR ▲▼ buttons can also be used to cycle through pages.

* The adjusted SYSTEM parameters will be memorised automatically.

SYSTEM Menu Parameters & Functions

1 Utility

1. System Tuning

VALUE: 427.0 ~ 453.0 Hz

This parameter sets the global master tuning of the MP7SE in 0.5Hz increments.

* The default setting is A = 440.0 Hz

2. Eff. SW Mode

PRESET, TEMP., FIXED

This function determines whether selecting sounds affects the EFX, AMP, and REVERB button state and associated settings.

Mode	Description
Preset	ON/OFF state is recalled when selecting sounds.
Temp.	ON/OFF state is not recalled when selecting sounds.
Fixed	ON/OFF state and effect settings are not recalled when selecting sounds.

* The default setting is Preset.

Using the Eff.SW Mode 'Fixed' function to copy effects settings

The following procedure can be used to 'copy' favourite effects settings to multiple sounds within the same section.

1. First, select the sound with the desired effects settings.

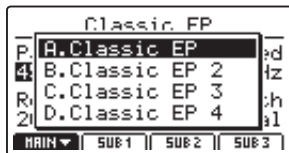

2. Enter the SYSTEM:Utility menu and set Eff.SW Mode to Fixed.

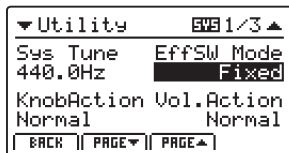

3. Next, select the sound to which the desired EFX settings should be applied.

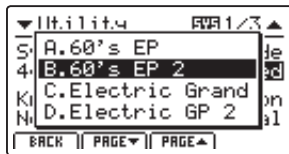

4. Then, store the sound (with the desired EFX settings) to memory.



5. Finally, restore the Eff.SW Mode to Preset.

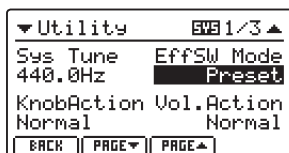

* The above procedure will 'copy' all EFX1/EFX and AMP settings, and the REVERB depth setting. Other settings will not be 'copied'.

3. Knob Action

NORMAL, CATCH

This parameter determines the adjustment behaviour of the four control knobs (A, B, C, D).

Mode	Description
Normal	Value changes immediately when control knob is turned.
Catch	Value does not change until control knob 'catches' the previously stored value, thus preventing unexpected jumps in parameter values.

* The default setting is Normal.

5. LCD Contrast

VALUE: 1 ~ 10

This parameter adjusts the contrast of the LCD display. The contrast becomes sharper as the value increases.

* The default setting is 5.

7. Input Level

VALUE: -18 dB ~ +18 dB

This parameter adjusts the gain of the MP7SE's LINE IN jacks.

If the output level of the external device is too high, reduce the value of this parameter. Alternatively, if the output is too low, increase the value of this parameter.

* The default setting is 0 dB.

9. Lock SW Mode

6 TYPES

This function determines which controls will be locked when the LOCK (🔒) button is pressed.

Mode	Description
Panel	The main control panel will be locked.
Bend	The pitch bend wheel will be locked.
Mod.	The modulation wheel will be locked.
Center	The centre pedal will be locked.
Left	The left pedal will be locked.
EXP	The expression pedal (EXP) will be locked.

* The default setting is Panel Lock.

11/12. SW1/SW2 Mode

3 FUNCTIONS

This parameter determines the global operation for the assignable SW1/SW2 buttons.

4. Volume Fader Action

NORMAL, CATCH

This parameter determines the adjustment behaviour of the section volume faders.

Mode	Description
Normal	Volume changes immediately when fader is moved.
Catch	Volume does not change until fader 'catches' the previously stored volume value, thus preventing unexpected volume jumps.

* The default setting is Normal.

6. LCD Reverse

ON, OFF

This parameter inverts the black and white pixels of the LCD display, which may improve visibility in certain situations.

* The default setting is OFF.

8. Audio Out Mode

STEREO, 2xMONO

This parameter allows the MP7SE's LINE OUT signal to be changed from stereo to dual-mono.

This may be useful in certain situations, allowing one output to be used for a monitor speaker and the other to be plugged into the mixing console.

Mode	Description
Stereo	The Line-out signal is normal stereo.
2xMono	The Line-out signal is mono on both jacks.

* The default setting is Stereo.

* Stereo EFX such as AutoPan will be turned OFF when 2xMono is selected.

10. Auto Power Off

OFF, 15 MINS., 60 MINS., 120 MINS.

This parameter determines the period of inactivity that should pass before the MP7SE automatically turns OFF.

Value	Description
Off	The Auto Power Off function is disabled.
15 mins.	The MP7SE will turn off after 15 minutes of inactivity.
60 mins.	The MP7SE will turn off after 60 minutes of inactivity.
120 mins.	The MP7SE will turn off after 120 minutes of inactivity.

* The default setting for this parameter depends on the market region.

SW modes

Mode	Description
Normal	The button will use the assigned EDIT menu function.
Setup+	The button will select the next SETUP memory.
Setup-	The button will select the previous SETUP memory.

2 Pedal/Mod.

1. Damper Pedal Mode

5 FUNCTIONS

This parameter determines the global operation for the included F-10H damper pedal.

* The default setting is Normal.

3. FSW Pedal Mode

5 FUNCTIONS

This parameter determines the global operation for the footswitch (FSW) pedal.

* The default setting is Normal.

5. Modulation Wheel Curve

NORMAL, SLOW, FAST

This parameter changes the output level curve for the modulation wheel, providing additional control over the speed of modulation wheel controlled effects.

* The default setting is Normal.

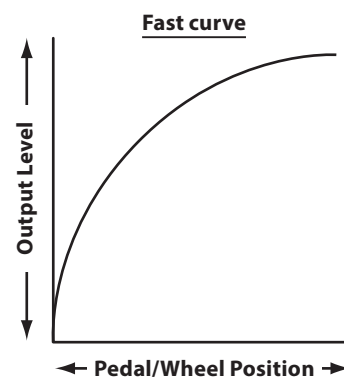
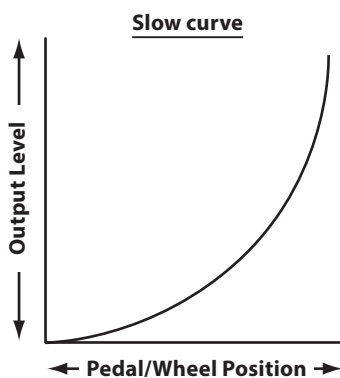
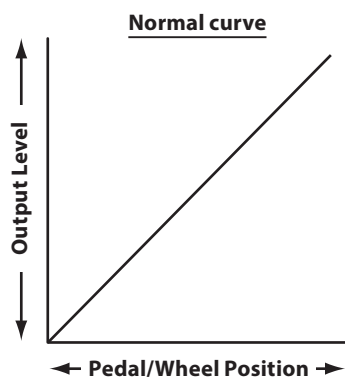

7. Right Pedal Mode

5 FUNCTIONS

This parameter determines the global operation for the right pedal of the optional GFP-3 pedal unit.

* The default setting is Normal.

9. Left Pedal Mode

5 FUNCTIONS

This parameter determines the global operation for an ordinary foot switch pedal or the left pedal of the optional GFP-3 pedal unit.

* The default setting is Normal.

2. Half Pedal Adjust

VALUE: 1 ~ 10

This parameter adjusts the point at which the damper/sustain pedal becomes effective (i.e. when the dampers of the piano begin to lift from the strings).

This parameter may be useful for pianists that habitually rest their right foot on the damper/sustain pedal, but do not necessarily wish to sustain the sound.

* The default setting is 5.

4. FSW Pedal Polarity

NORMAL, REVERSE

This parameter changes the polarity of the ordinary footswitch (FSW) pedal.

The MP7SE's foot switch terminal is designed for use with 'Normal Close' polarity pedals. If using a foot switch with 'Normal Open' polarity, please change this parameter to Reverse.

* The default setting is Normal.

6. EXP Pedal Curve

NORMAL, SLOW, FAST

This parameter changes the output level curve for the connected expression (EXP) pedal, providing additional control over the speed of expression pedal controlled effects.

* The default setting is Normal.

8. Center Pedal Mode

5 FUNCTIONS

This parameter determines the global operation for the centre pedal of the optional GFP-3 pedal unit.

* The default setting is Normal.

■ Pedal modes

Mode	Description
Normal	The pedal will use the assigned EDIT menu function.
Setup+	The pedal will select the next SETUP memory.
Setup-	The pedal will select the previous SETUP memory.
Playback	The pedal will start/stop song playback.
Metro.	The pedal will start/stop the metronome.

Expression pedal calibration

Depending on the brand and model of expression pedal connected to the MP7SE, it may be necessary to use the calibration function to ensure that the pedal's minimum and maximum range of values are detected correctly.

■ Calibrating the EXP pedal

Select the third page (3/3) of the Pedal SYSTEM menu.

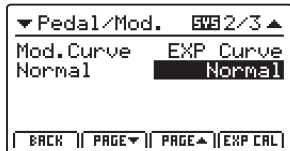

Press the F4 function button (EXP CAL) to show the expression pedal calibration screen in the LCD display.

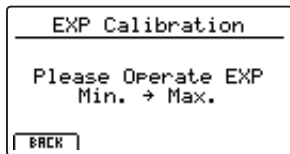

Press the expression pedal to the minimum and maximum positions several times to transmit the full range of values.

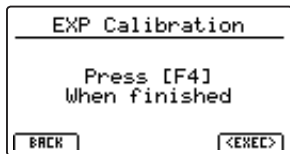
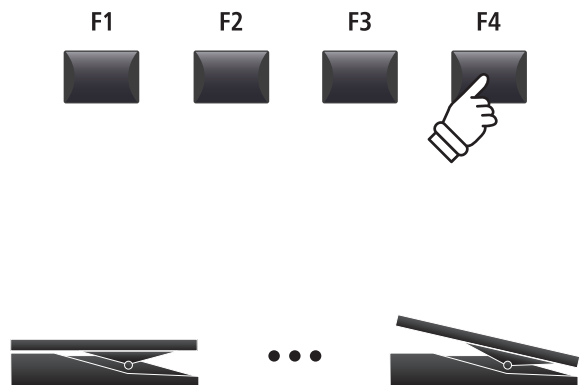

Press F4 function button (EXEC) to complete the expression pedal calibration.



The full range of operation for the connected expression pedal will be calculated automatically.

3 MIDI

1. System Channel

VALUE: 01CH ~ 16CH

This parameter determines the System MIDI channel used to receive MIDI messages when Receive Mode is set to Panel.

* The default setting is 01Ch.

3. Key to USB

ON, OFF

This parameter determines whether or not keyboard events are transmitted via USB-MIDI.

* The default setting is ON.

5. MIDI to USB

ON, OFF

This parameter determines whether or not received MIDI IN events are transmitted via USB-MIDI.

* The default setting is OFF.

7. SETUP Program

ON, OFF

This parameter determines whether or not the Send Program parameter in the EDIT menu (MIDI OUT/SETUP) is enabled.

* For more information about the Send Program parameter, please refer to page 56.

* The default setting is OFF.

9. SETUP Volume

ON, OFF

This parameter determines whether or not the Send Volume parameter in the EDIT menu (MIDI OUT/SETUP) is enabled.

* For more information about the Send Volume parameter, please refer to page 56.

* The default setting is OFF.

11. Receive Mode

PANEL, MULTI, OMNI ON

This parameter determines how the MP7SE receives MIDI data.

Mode	Description
Panel	Only data received from the designated system channel will be sent to the MAIN, SUB1, SUB2, and SUB3 zones. * With this setting, layer and internal effects will be available.
Multi	Data received from all MIDI channels (ch1~ch16) will be sent to the MAIN and SUB1, SUB2, SUB3 zones or MIDI channels. * With this setting, an additional set of pages will appear, allowing MIDI Receive Channels to be specified.
Omni On	Received data controls the whole panel, regardless of the MIDI channel.

* The default setting is Panel.

2. Key to MIDI

ON, OFF

This parameter determines whether or not keyboard events are transmitted via MIDI OUT.

* The default setting is ON.

4. MIDI to MIDI

ON, OFF

This parameter determines whether or not received MIDI IN events are transmitted via MIDI OUT.

* The default setting is OFF.

6. USB to MIDI

ON, OFF

This parameter determines whether or not received USB-MIDI events are transmitted via MIDI OUT.

* The default setting is OFF.

8. SETUP Bank

ON, OFF

This parameter determines whether or not the Send Bank parameter in the EDIT menu (MIDI OUT/SETUP) is enabled.

* For more information about the Send Bank parameter, please refer to page 56.

* The default setting is OFF.

10. SETUP Knobs

ON, OFF

This parameter determines whether or not the Send Knobs parameter in the EDIT menu (MIDI OUT/SETUP) is enabled.

* For more information about the Send Knobs parameter, please refer to page 56.

* The default setting is OFF.

12. Program Change Mode

PANEL, GM

This parameter determines the sound numbering format that is used when sending MIDI Program Change information.

Mode	Description
Panel	Program Change data is sent in accordance with the instrument's panel button numbering format.
GM	Program Change data is sent in accordance with the standard GM numbering format. * Select this setting when connecting the MP7SE to GM devices.

* The default setting is Panel.

13. Receive Channel

ON, OFF,
MAIN, SUB1, SUB2, SUB3

When Receive Mode is set to 'Multi', these additional settings determine whether the Receive Channel is turned ON or OFF, or assigned to a specific zone.

* When set to MAIN, SUB1, SUB2, or SUB3, the MIDI input signal will still trigger sounds even when the zone is turned OFF.

4 Offset

1. EQ Offset ON/OFF ON, OFF

This parameter turns the EQ Offset function ON or OFF.

The EQ Offset function may be useful when performing at a venue with certain room acoustics, or simply different amplifier and speaker equipment to that used normally. The Offset values can be adjusted to create a 'baseline' character for the instrument, rather than readjusting the EQ settings prepared for each SETUP.

* The default setting is OFF.

* The EQ Offset values will be added to the EQ values defined in each SETUP. The combined EQ values are limited to ± 10 dB.

3. EQ Offset Low VALUE: -10 dB ~ +10 dB

This parameter adjusts the EQ Offset gain for the low range frequency band.

* The default setting is 0 dB.

5. EQ Offset Mid1 VALUE: -10 dB ~ +10 dB

This parameter adjusts the EQ Offset gain for the Mid1 range frequency band.

* The default setting is 0 dB.

2. Reverb Offset VALUE: 0% ~ 100%

This parameter adjusts the reverb depth offset, allowing the reverb for all sound section to be reduced globally.

Similar to the EQ Offset function, Reverb Offset may be useful when performing at a venue with reflective acoustics, or when connecting the instrument to a PA system with reverb pre-applied. The reverb offset depth is reduced globally for all sound sections, negating the need to readjust reverb settings for each SETUP.

* The default setting is 100%.

4. EQ Offset High VALUE: -10 dB ~ +10 dB

This parameter adjusts the EQ Offset gain for the high range frequency band.

* The default setting is 0 dB.

6. EQ Offset Mid2 VALUE: -10 dB ~ +10 dB

This parameter adjusts the EQ Offset gain for the Mid2 range frequency band.

* The default setting is 0 dB.

5 User Edit

The User Edit category contains functions to create custom touch curves and keyboard temperaments.

■ Selecting the User Touch Curve / Temperament / Key Volume / Stretch Tuning to edit

After selecting the User Edit SYSTEM menu category:

Turn control knob A to select the desired User Touch Curve.
 Turn control knob B to select the desired User Temperament.
 Turn control knob C to select the desired User Key Volume.
 Turn control knob D to select the desired User Stretch Tuning.

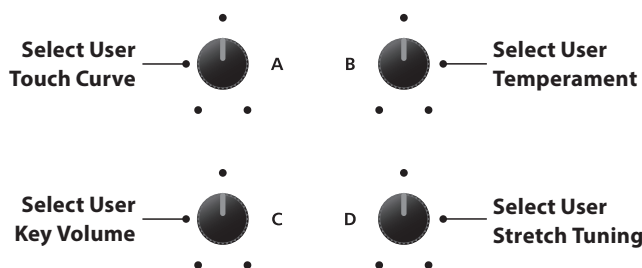

The User Touch Curve, User Temperament, User Key Volume, and User Stretch Tuning can also be selected by using the CURSOR buttons and +/YES or -/NO buttons.

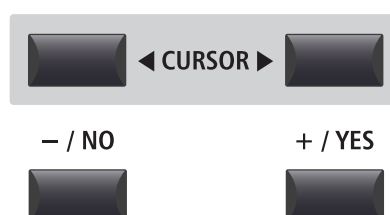
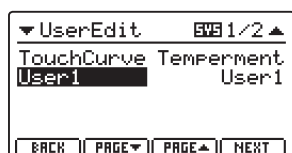

Creating a User Touch Curve

1. Starting the User Touch Curve analysis

After selecting the User Touch Curve memory to be edited:

Press the F4 function button (NEXT) to start the User Touch Curve analysis.

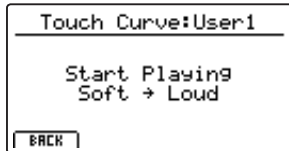

2. Capturing the dynamic range

Play the piano dynamically from very soft to very loud, allowing the instrument to analyse the personal playing technique.

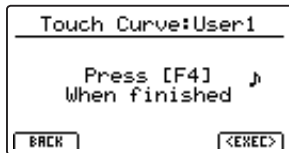
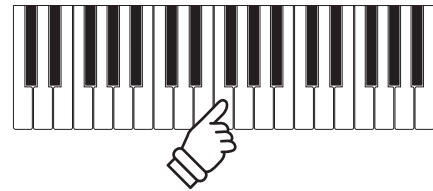

3. Completing the User Touch Curve analysis

Press the F4 function button (EXEC) to complete the User Touch Curve analysis.

A confirmation screen will be shown in the LCD display.

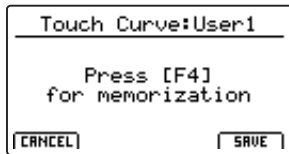

Play the piano to check the newly created touch curve, then press the F4 function button (SAVE) to store it to user memory.



4. Storing the User Touch Curve

Press the F2 button (YES) to confirm the store operation, or the F3 button (NO) to return to the previous screen.

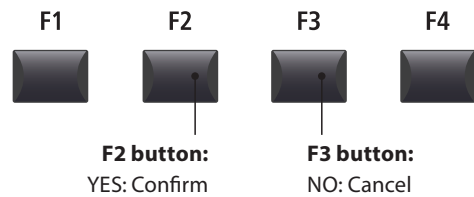
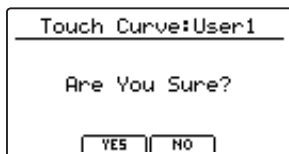

* The +/YES and -/NO buttons can also be used to confirm or cancel the store operation.

The new User Touch Curve will be used for the selected sound section temporarily.

* More than one attempt may be required in order to create an accurate User Touch Curve.

* Reducing the master volume fader to the lowest position before creating the User Touch Curve may help to reduce user distractions, thus improving accuracy.

* Please use the Store SOUND function to ensure that the created User Touch Curve is used automatically when the sound is selected.

Creating a User Temperament

1. Selecting the User Temperament editor

After selecting the User Temperament to be edited:

Press the F4 function button (NEXT) to select the User Temperament editor.

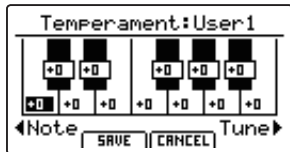

2. Adjusting the User Temperament

Turn control knob C to select the note to be adjusted.
Turn control knob D to adjust the pitch of the selected note.

- * The pitch of each key can be adjusted within the range of -50 ~ +50 cents.
One semi-tone = 100 cents.
- * To select a note directly, press the desired key.

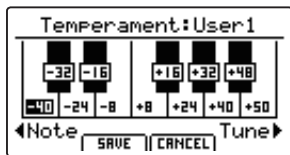

3. Saving the User Temperament

After adjusting the note pitches:

Press the F2 function button (SAVE) to save the adjusted User Temperament.

A store confirmation screen will be shown in the LCD display.

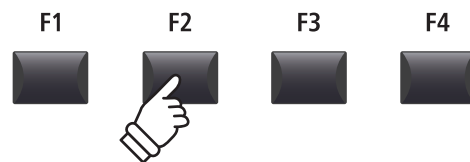
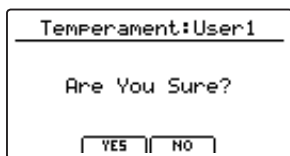

4. Confirming the store operation

Press the F2 button (YES) to confirm the store operation, or the F3 button (NO) to return to the previous screen.

- * The +/YES and -/NO buttons can also be used to confirm or cancel the store operation.

The new User Temperament will be used for the selected sound section temporarily.

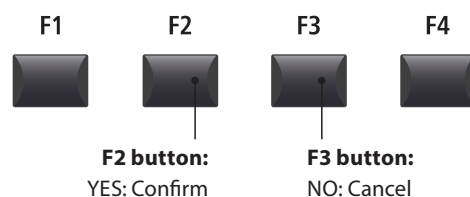

* Please use the Store SOUND function to ensure that the created User Temperament is used automatically when the sound is selected.

Creating a User Key Volume

1. Selecting the User Key Volume editor

After selecting the User Key Volume to be edited:

Press the F4 function button (NEXT) to select the User Key Volume editor.

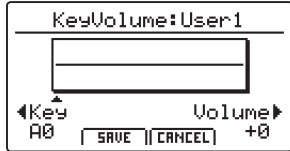

2. Adjusting the User Key Volume

Turn control knob C to select the key to be adjusted.
Turn control knob D to adjust the volume of the selected key.

* The volume of each key can be adjusted within the range of -50 ~ +50.

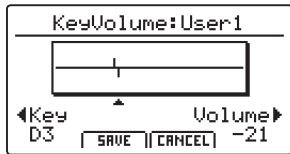

3. Saving the User Key Volume

After adjusting the key volumes:

Press the F2 function button (SAVE) to save the adjusted User Key Volume.

A store confirmation screen will be shown in the LCD display.

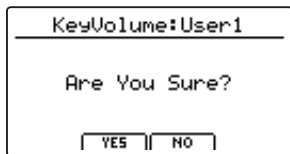
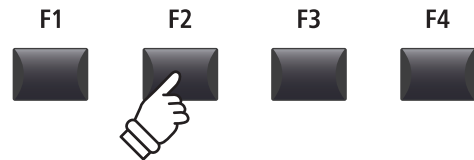

4. Confirming the store operation

Press the F2 button (YES) to confirm the store operation, or the F3 button (NO) to return to the previous screen.

* The +/YES and -/NO buttons can also be used to confirm or cancel the store operation.

The new User Key Volume will be used for the selected sound section temporarily.

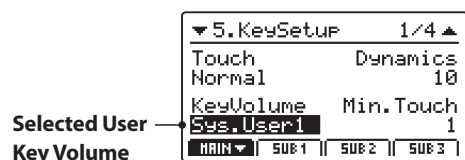
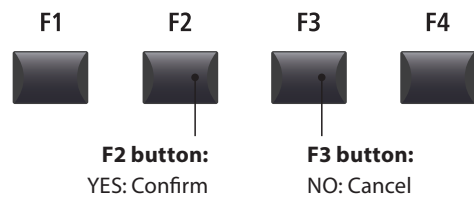

* Please use the Store SOUND function to ensure that the created User Key Volume is used automatically when the sound is selected.

Creating a User Stretch Tuning

1. Selecting the User Stretch Tuning editor

After selecting the User Stretch Tuning to be edited:

Press the F4 function button (NEXT) to select the User Stretch Tuning editor.

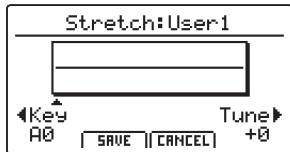

2. Adjusting the User Stretch Tuning

Turn control knob C to select the key to be adjusted.
Turn control knob D to adjust the pitch of the selected key.

- * The pitch of each key can be adjusted within the range of -50 ~ +50 cents.
One semi-tone = 100 cents.
- * To select a note directly, press the desired key.

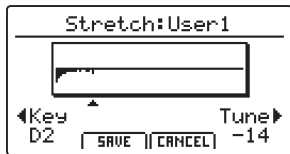

3. Saving the User Stretch Tuning

After adjusting the key pitches:

Press the F2 function button (SAVE) to save the adjusted User Stretch Tuning.

A store confirmation screen will be shown in the LCD display.

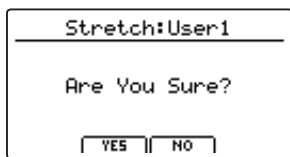
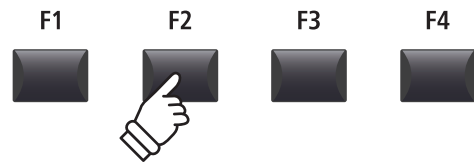

4. Confirming the store operation

Press the F2 button (YES) to confirm the store operation, or the F3 button (NO) to return to the previous screen.

- * The +/YES and -/NO buttons can also be used to confirm or cancel the store operation.

The new User Stretch Tuning will be used for the selected sound section temporarily.

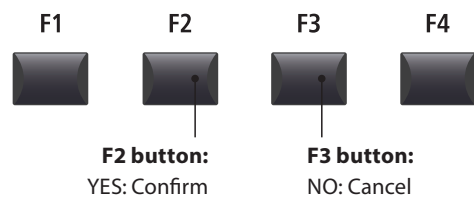

* Please use the Store SOUND function to ensure that the created User Stretch Tuning is used automatically when the sound is selected.

Creating a User Voicing

1. Selecting the User Voicing Tuning editor

After selecting the User Voicing to be edited:

Press the F4 function button (NEXT) to select the User Voicing editor.

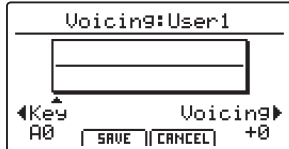

2. Adjusting the User Voicing

Turn control knob C to select the key to be adjusted.

Turn control knob D to adjust the voicing of the selected key.

- * The User Voicing value can be adjusted within the range of -5 ~ +5, with lower values creating a mellower sound and higher values creating a brighter sound.
- * To select a note directly, press the desired key.

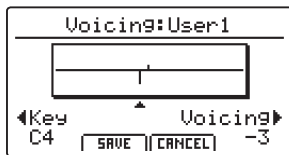

3. Saving the User Voicing

After adjusting the user voicing value:

Press the F2 function button (SAVE) to save the adjusted User Voicing.

A store confirmation screen will be shown in the LCD display.

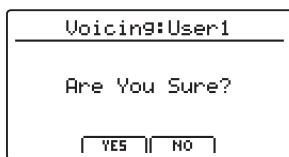
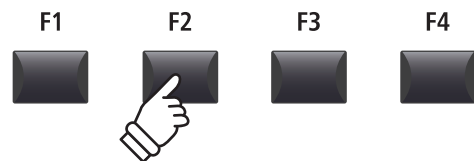

4. Confirming the store operation

Press the F2 button (YES) to confirm the store operation, or the F3 button (NO) to return to the previous screen.

- * The +/YES and -/NO buttons can also be used to confirm or cancel the store operation.

The new User Voicing will be used for the selected sound section temporarily.

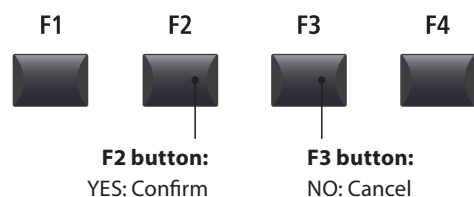

- * Please use the Store SOUND function to ensure that the created User Voicing is used automatically when the sound is selected.

6 Reset

The Reset category contains functions to reset sounds, setups, and settings back to the original factory default.



Once performed, these Reset functions cannot be undone.
Exercise caution when using this function in order to prevent accidental data loss.

1. Reset One Sound

This function resets the currently selected sound to the factory default.

The currently selected sound will be shown in the LCD display.

* It is also possible to select the sound to be reset by pressing the sound category and variation buttons.

2. Reset One Setup

This function resets the currently selected SETUP memory to the factory default.

The currently selected SETUP will be shown in the LCD display.

* It is also possible to select the SETUP memory to be reset by pressing the BANK ◀▶ buttons and SETUP memory buttons.

3. Reset All Sound

This function resets all sounds to the factory default.

4. Reset All Setup

This function resets all SETUP memories to the factory default.

5. Reset System

This function resets all SYSTEM parameters, including Utility, Pedal, Offset, and MIDI parameters in the SYSTEM menu, and SETUP, Transmit, and MMC parameters in the MIDI section EDIT menu.

6. Reset PowerOn

This function resets the PowerOn memory to the factory default.

7. Reset Recorder

This function resets all internal song recorder memories.

8. Factory Reset

This function performs a global reset of all sounds, SETUPS, SYSTEM settings, and internal song recorder memories.

Panic button

The PANIC button restores all internal sounds to their default PowerOn setting, and also sends the AllNoteOff and ResetAll Controller MIDI messages to any connected devices (01ch ~ 16ch).

This is a useful function to be used in emergency situations, or to immediately restore the MP7SE to a preferred configuration.

■ Activating the Panic function

Press and hold the PANIC button.

After one second, the MP7SE will be returned to the default PowerOn configuration.

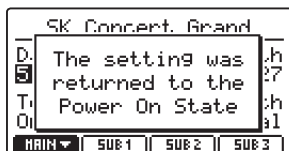

PANIC



Panel Lock (🔒)

The Lock (🔒) function allows the state of the MP7SE's various controls to be temporarily locked, preventing accidental button pushes, pedal presses, or wheel movements.

■ Activating and deactivating the Lock function

Press the LOCK (🔒) button.

The LED indicator for the LOCK (🔒) button will turn on, and the lock pop-up will briefly be shown in the LCD display.

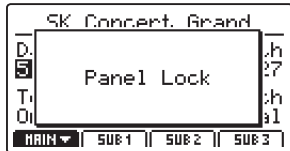

By default (Panel Lock mode), the Lock function will lock all of the MP7SE's panel buttons, knobs, and section VOLUME faders, preventing any accidental adjustments during performances etc.

* The VOLUME and LINE IN faders will not be locked. The keyboard will also remain active.

Press the LOCK (🔒) button again to deactivate the lock.



■ Changing the Lock mode

Press and hold the LOCK (🔒) button, then press the +/YES or -/NO buttons to cycle through the different Lock modes.

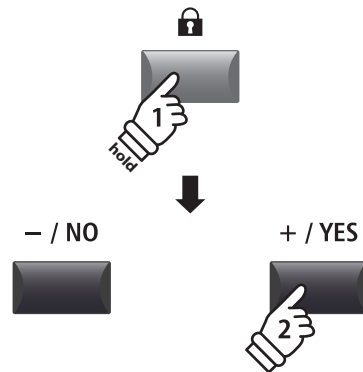
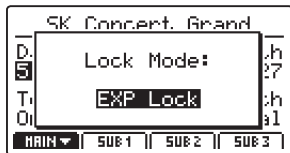
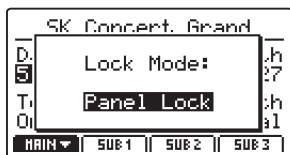

* The Lock mode can also be changed in the SYSTEM menu. For more information, please refer to page 107.

■ Lock modes

Lock mode	Description
Panel Lock	The main control panel buttons, knobs, and section VOLUME faders will be locked.
Bend Lock	The pitch bend wheel will be locked.
Mod. Lock	The modulation wheel will be locked.
Center Lock	The centre pedal will be locked.
Left Lock	The left pedal will be locked.
EXP Lock	The expression pedal (EXP) will be locked.

Troubleshooting

Power		Page
The instrument does not turn on.	Check that the AC power adaptor is firmly attached to the instrument, and connected to an AC outlet.	16
The instrument turns itself off after a period of inactivity.	Check that the 'Auto Power Off' setting is not enabled.	107
Sound		Page
The instrument is turned on, however no sound is produced when the keys are pressed.	The MP7SE does not feature built-in speakers. Check that a mixer, keyboard amplifier, or headphones are connected to the instrument correctly. If using an external mixer or amplifier, check that the settings are correct.	18
	Check that the MASTER VOLUME fader is not set to the lowest position.	12
	Check that at least one zone's ON/OFF button is turned on.	22
	Check that at least one zone is set to INT or BOTH mode. The red LED above the ON/OFF button (INT) should be lit.	23
	Check that at least one zone's VOLUME fader is not set to the lowest position.	22
	Check that the LOCAL OFF button is not turned on.	37
	Check that the expression pedal is not set to the minimum position.	17
	Check that the  MasterVol parameter in the EDIT menu is not set to 0.	42
No sound is produced for a part of zones or the sound volume is reduced.	Check that the zone's ON/OFF button is turned on.	22
	Check that the zone is not set to EXT mode. The red LED above the ON/OFF button (INT) should be lit.	23
	Check that the zone's VOLUME fader is not set to the lowest position.	22
	Check that the zone's ON/OFF button is not green. If it is green, please check the Key Range parameter setting in the EDIT menu.	24 47
	Check that the AMP level parameter in the EDIT menu is not set to 0.	41
	Check that the modulation wheel is not assigned to the 'Expression' function.	49
	Check that the Receive Mode parameter in the SYSTEM:MIDI menu is not set to 'Multi', and the Receive Channel is not set to MAIN or SUB1~3. Some control change messages may affect the volume faders and/or the EDIT menu parameters in section Receive mode. If playing separate sections by MIDI or control change is not required, please set the Receive Mode parameter to 'Panel'.	110 158
The sound distorts when playing at very loud volume levels.	Check that the MASTER VOLUME fader is set to an appropriate level, reducing the volume if excessive distortion is heard.	12

Troubleshooting

Strange sounds or noises are heard when playing with piano sounds.	The MP7SE stage piano attempts to reproduce the rich variety of tones created by an acoustic grand piano as accurately as possible. This includes various resonances, noises, and other subtle characteristics that contribute to the overall piano playing experience. While these additional tones are intended to enhance the realism of the instrument, it is possible to reduce their prominence, or disable the effects altogether using the following settings in the Virtual Technician menu.	
	The noise occurs when the damper pedal is depressed and released. ➔ Damper Noise	52
	The noise occurs after a key is released. ➔ Fall-back Noise, Key-off Effect	52
	The sound has a metallic characteristic. ➔ Key-off Effect, Undamped Resonance, String Resonance	52
	The sound is muffled or too bright. ➔ Topboard, Voicing	52
	A particular key's level/volume is higher than other keys. ➔ User KeyVolume	114
The keyboard has no touch responsiveness.	A particular key's pitch is heard as incorrect. ➔ Temperament, User Temperament, User StretchTuning	45 113 115
	Check that the Touch Curve parameter in the EDIT menu is not set to Off.	46
	Check that the Dynamics parameter in the EDIT menu is not set to Off. When the Dynamics parameter is set to Off, touch response will be disabled.	46
	Check that the Trigger Mode parameter in the EDIT menu is not set to Fast. When the Trigger Mode parameter is set to Fast/Fast2, touch response will be disabled.	47
Staccato playing causes double notes when Trigger Mode is set to Fast.	Some synth sounds such as SynthBass or SawLead etc. are intentionally prepared not to use touch response. Please adjust the DCA Touch Depth or DCF Touch Depth parameters to adjust this characteristic.	42
Sound cuts out momentarily when selecting a Tonewheel organ sound.	When entering/exiting Tonewheel organ mode (assigned to DRAWBAR sub-categories 1~3), there may be a brief loss of sound as the tonewheel simulator is activated/deactivated. This is normal behaviour.	32

STORE		Page
OctaveShift cannot be stored to a SOUND memory.	This is the correct behaviour. Some parameters related to the key range/velocity functions (OctaveShift, ZoneTranspose, KeyRangeLo/Hi, VelocitySwitch) are not stored to SOUND memory, but to SETUP memory only.	
The POWER ON default setting is different to the setting that it is stored.	The POWERON memory will only store the selected SOUND position, not the individual EDIT menu settings of that SOUND. In order to memorise EDIT menu settings, please store each zone's sound to the SOUND memory.	64 66
The metronome click/rhythm pattern does not change when the SETUP is selected.	Please store preferred metronome click/rhythm pattern settings to SETUP memory. However, please note that if the metronome click or rhythm pattern is running while a SETUP is selected, the metronome settings will not change.	65 93

Pedal, Controller		Page
Pedals or wheels don't work.	Check that the controller is not set to Off in the EDIT:Controllers menu.	49 60
	Check that the included F-10H damer pedal is not connected to the 'FSW' or 'EXP' jack. Please connect the included F-10H damper pedal to the correct 'DAMPER (F-10H)' jack.	18
The Modulation Depth Range parameter has no effect.	Check that the modulation wheel function is set to 'Modulation' in the EDIT menu. If not, the Modulation Depth Range parameter will have no effect.	49
The foot switch pedal does not work and a malfunction occurs in the MP7SE.	Check that the foot switch pedal is not connected to the 'DAMPER (F-10H)' or 'EXP' jack. Please connect the foot switch pedal to the 'FSW' jack.	18
The foot switch does not turn off after releasing the pedal.	Check that the foot switch pedal is a 'Normal Closed' polarity type. If using a 'Normal Open' polarity type, please set the FSW Polarity setting in the SYSTEM:Pedal/Mod. menu to Reverse.	108
The expression pedal does not work and a malfunction occurs with the MP7SE.	Please check that the expression pedal's TRS connector type is set correctly, using the EXP TYPE switch on the rear jack pack.	17
The top 18 notes of the keyboard sustain for longer than neighbouring notes, even when the damper pedal is not pressed.	This is the correct behaviour, and intended to reproduce the undamped notes (typically the top two octaves) of an acoustic grand piano.	
The sound continues to sustain after the damper pedal is released and re-pressed.	This is the correct behaviour, and reproduces the ability to sustain notes when quickly re-pressing the damper pedal of an acoustic grand piano.	

Line In		Page
The volume of the device connected to the Line In jacks is too low/too high (distorted).	Check the position of the LINE IN fader, and adjust as necessary.	12
The adjustable range of the LINE IN fader is too narrow.	Adjust the Input Level in the SYSTEM:Utility menu.	107

MIDI		Page
The MP7SE's Song Recorder (Internal Memory) cannot record the MIDI section.	Check that the TransmitRecorder parameter in the EDIT:Transit menu is set to On. By default, this parameter is set to Off.	57
MMC cannot control the external device.	Check that the Transmit MMC parameter in the EDIT:MMC menu is set to On. By default, this parameter is set to Off.	57
	Check that the MMC device ID is set correctly, and matches the external device's ID. If theidignite is not necessary, please set to 127 (default, All).	57
	Check the external device's owner's manual to ensure that MMC messages are recognised.	
	Check that the external device's MIDI clock is not set to External. The MP7SE does not send MTC (MIDI Time Code) or MIDI Clock data, therefore the external device should be set to use its own internal clock.	

Troubleshooting

The damper pedal is not released when playing MIDI data.	If the damper pedal off/on events of the MIDI data are extremely short, there is the possibility that the MP7SE's piano sound sustains continuously. This is due to the MP7SE reproducing the ability to release and quickly re-press the damper pedal of an acoustic grand piano.	
When Receive Mode is set to 'Multi', received MIDI notes continue to play, even when the Zone is turned off.	<p>This is the correct behaviour, as the Zone ON/OFF buttons are only intended to connect/disconnect the MP7SE's keyboard from the internal tone generator.</p> <p>This allows the MP7SE's sounds to be triggered externally, without being played by the instrument's keyboard. For example, external MIDI keyboard controlling bass sound in SUB section, while the full MP7SE keyboard is used for the PIANO section.</p> <ol style="list-style-type: none"> 1. Select the desired piano sound in the MAIN zone and a bass sound in the SUB1 zone. 2. Turn of the SUB1 zone using the ON/OFF button. 3. Set SYSTEM:MIDI Receive Mode to 'Multi' and Rcv.Ch3 to SUB1. 4. Set the MIDI transmit channel to 3 for the external MIDI keyboard. 	22 110
	Check that the Receive Channel is set to the desired zone (MAIN or SUB1~3).	110

USB to HOST Page

The instrument is connected to the computer using a USB cable, however the software does not respond to key presses.	Check that a USB MIDI driver is installed on the computer.	124
	Check that 'USB Audio Device' or 'KAWAI USB MIDI' is selected in the software's input/output device settings.	124

USB to DEVICE Page

A USB memory device is not detected, cannot be saved to, or does not appear to function when connected to the 'USB to Device' port.	Check that the USB memory device is formatted to use the FAT/FAT32 filesystem, and not set to 'Write Protect' mode.	16
	Disconnect the USB memory device, turn the instrument off then on, then reconnect the USB device. If the USB device still does not function, it may be damaged or incompatible. Please try using a different USB device.	
	Ensure that the USB memory device is not a wireless flash drive. Such devices are not compatible with the MP7SE.	
The instrument pauses briefly when connecting a USB memory device.	This is recognised behaviour when using large capacity (e.g. 8GB+) USB memory devices.	
The current SOUND/SETUP setting is not stored correctly when saved to a USB memory device.	Ensure that the desired SOUND/SETUP setting has first been stored to internal memory before being saved to a USB memory device.	64 65 101

MP3/WAV Audio, SMF Page

No sound can be heard when playing an MP3/WAV audio file stored on a USB memory device.	Check that the audio player volume is not set to 0.	85
	Check that the format of the audio file is supported and listed in the 'Audio Player supported format specifications' table.	84
An MP3/WAV audio file stored on a USB memory device sounds strange, or does not play back correctly.	Check that the format of the audio file is supported and listed in the 'Audio Player supported format specifications' table.	84
	The file transfer speed of the USB memory device may be too slow to play the audio file. Please try using a different USB memory device, ensuring that it conforms to USB2.0 Hi-Speed standards.	

An SMF (Standard MIDI file) sounds strange when played back or some parts don't playback.	The MP7SE loads SMF files into the instrument's Song Recorder (internal memory), which only supports one track + drum track. MIDI data that requires multiple tracks may therefore not playback correctly.	100
	When saving Song Recorder (internal memory) SMF files, the MP7SE includes additional system exclusive data for selecting sounds. The SMF file may therefore sound different when played back on devices other than the MP7SE.	
	The program change messages cannot be loaded to the MP7SE's internal MIDI recorder.	
	If an SMF file that does not include the MP7SE's additional setup information is loaded in to the Song Recorder (internal memory) the current sound's setting will be used. This can be checked by using the 'Listen' button before loading the SMF file.	100
	Please use the SMF Direct Play function instead of loading the file into the internal recorder memory. The SMF Direct Play function will play the SMF file directly from USB memory, and supports 16-track playback.	79
	The MP7SE stage piano does not contain the full General MIDI sound bank selection. Consequently, some SMF song files may not be reproduced entirely accurately when played through the instrument.	79
When recording MP3/WAV audio files, the volume is too low/too high (distorted).	Adjust the 'Audio Recorder Gain' setting in the SYSTEM:Utility menu.	82

USB MIDI (USB to Host connector)

The MP7SE features a 'USB to Host' type connector, allowing the instrument to be connected to a computer using an inexpensive USB cable and utilised as a MIDI device. Depending on the type of computer and operating system installed, additional driver software may be required for USB MIDI communication to function correctly.

■ USB MIDI driver

Operating System	USB MIDI Driver Support
Windows ME Windows XP (no SP, SP1, SP2, SP3) Windows XP 64-bit Windows Vista (SP1, SP2) Windows Vista 64-bit (SP1, SP2) Windows 7 (no SP, SP1) Windows 7 64-bit Windows 8 / 8.1 Windows 8 / 8.1 64-bit Windows 10 Windows 10 64-bit	Additional USB MIDI driver software NOT required. The standard (built-in) Windows USB MIDI driver will be installed automatically when the instrument is connected to the computer. * After driver installation, ensure that the 'USB Audio Device' (Windows ME/Windows XP) or 'USB-MIDI' (Windows Vista/Windows 7/Windows 8) device is correctly selected in the application software.
Windows 98 se Windows 2000 Windows Vista (no SP)	Additional USB MIDI driver software required. Please download the USB MIDI driver from the Kawai Global website: → http://www.kawai-global.com/support/downloads * After driver installation, ensure that the 'KAWAI USB MIDI' device is correctly selected in the application software.
Windows Vista 64-bit (no SP)	USB MIDI is not supported. Please upgrade to service pack 1 or service pack 2.
Mac OS X	Additional USB MIDI driver software NOT required. The standard (built-in) Mac OS X USB MIDI driver will be installed automatically when the instrument is connected to the computer.
Mac OS 9	USB MIDI is not supported. Please use the standard MIDI IN/OUT connectors.

■ USB MIDI information

- The instrument's USB MIDI port and MIDI IN/OUT jacks can be connected and used simultaneously. To adjust MIDI routing, please refer to the MIDI parameters in the SYSTEM menu, explained on page 110.
- Ensure that the instrument is turned OFF before attempting to connect the USB MIDI cable.
- When connecting the instrument to a computer using the USB MIDI port, there may be a short delay before communications begin.
- If the instrument is connected to a computer via a USB hub and USB MIDI communication becomes unreliable/unstable, please connect the USB MIDI cable directly to the one of the computer's USB ports.
- Disconnecting the USB MIDI cable suddenly, or turning the instrument on/off while using USB MIDI may cause computer instability in the following situations:
 - while installing the USB MIDI driver
 - while starting up the computer
 - while MIDI applications are performing tasks
 - while the computer is in energy saver mode
- If there are any further problems experienced with USB MIDI communication while the instrument is connected, please double-check all connections and relevant MIDI settings in the computer's operating system.

* 'MIDI' is a registered trademark of the Association of Manufacturers of Electronic Instruments (AMEI).

* 'Windows' is registered trademark of Microsoft Corporation.

* 'Macintosh' is registered trademark of Apple Inc.

* Other company names and product names mentioned referenced herein may be registered trademarks or trademarks of respective owners.

Software Update

This page contains instructions for updating the system software of the MP7SE, when issued by Kawai. Please read these instructions thoroughly before attempting to perform the software update.



This update will clear any user-created SOUNDS/SETUPS stored in memory. To retain this data, please use the AllBackup function before updating.

■ Checking the software version

To check the current software version installed on the MP7SE, press and hold the STORE button, then turn the instrument ON.

The current software (Program) version will be shown on the first line of the LCD display.

If the Program version number is greater than or equal to the update version, no further action is necessary.

* Turn the instrument off and on to return to normal operation.

If the Program version number is lower than the update version, please continue to follow the instructions below.

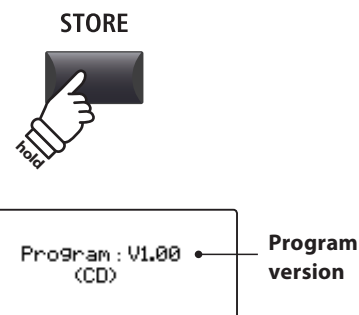

1. Prepare the USB memory device

Extract the software update ZIP file and copy the included .SYS files to the root folder of a USB memory device.

* USB devices should be formatted to use the 'FAT' or 'FAT32' filesystems.



2. Connect the USB memory device

While the instrument is turned off:

Connect the prepared USB memory device to the USB port.



3. Start the update

Press and hold buttons 6, 7, and 8 in the middle row of the SOUND/SETUP section, then turn the instrument ON.

The update process will start automatically after a few seconds, and status messages will be shown in the LCD display.

* Do not remove the USB memory device while the software update is in progress.

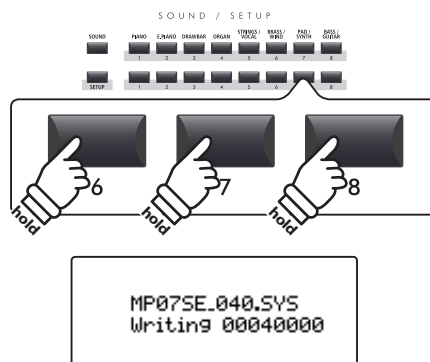

4. Finish the update, disconnect the USB memory device

After approximately 60-90 seconds (depending on the number of update files), a message will be shown in the LCD display, indicating that the software update has been successful.

Disconnect the USB memory device, then press and hold the POWER switch to turn the instrument OFF. When the instrument is turned ON, the updated software will be used automatically.

* If the software update is unsuccessful, restart the process from step 1.

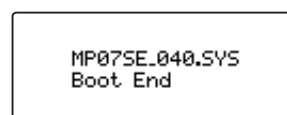

Sound List

		PIANO	E.PIANO	DRAWBAR	ORGAN
1	A	SK Concert Grand	Classic EP	T.Wheel 1-A	Church Organ
	B	SK Studio Grand	Classic EP 2	T.Wheel 1-B	Full Pipes
	C	SK Mellow Grand	Classic EP 3	T.Wheel 1-C	Full Ensemble
	D	Standard Grand	Classic EP 4	T.Wheel 1-D	Church Organ 2
2	A	EX Concert Grand	Modern EP	T.Wheel 2-A	PrincipleChoir
	B	EX Studio Grand	Modern EP 2	T.Wheel 2-B	Small Ensemble
	C	EX Mellow Grand	Modern EP 3	T.Wheel 2-C	Small Ens. 2
	D	EX Jazz Grand	Modern EP 4	T.Wheel 2-D	Baroque
3	A	SK-5 Grand	60's EP	T.Wheel 3-A	Chiffy Tibia
	B	SK-5 StudioGrand	60's EP 2	T.Wheel 3-B	8'&4'Principle
	C	SK-5 MellowGrand	Electric Grand	T.Wheel 3-C	Stopped Pipe
	D	Studio Grand	Electric GP 2	T.Wheel 3-D	Principle Pipe
4	A	Upright Piano	Dolce EP	Blues Organ	8' Celeste
	B	Bright Upright	Legend EP	Drawbar Organ	Diapason
	C	Old Upright	Phase EP	Drawbar Organ2	Voice Celeste
	D	Honky Tonk	Classic EP 5	Gospel Organ	Baroque Mix
5	A	PopPiano	Crystal EP	Ballad Organ	Reeds
	B	Bright Pop Piano	New Age EP	Soft Solo	8' Reed
	C	Pop Piano 2	New Age EP2	Odd Man	Reed Pipes
	D	Pop Piano 3	New Age EP3	Be Nice	Posaune
6	A	Modern Piano	Clavinet	Jazz Organ	Theater Organ
	B	Mono SK-EX Grand	Synth Clavinet	Drawbar Organ3	Theater Organ2
	C	Mono EX Grand	Clavi & Marim	Perc. Organ	Theater Organ3
	D	GM Piano	Clavi Phaser	Perc. Organ 2	Theater Tibia
7	A	Rock Piano	Vibraphone	Drawbar Organ4	Elec. Organ
	B	Piano Oct.	Celesta	Full Organ	Elec. Organ 2
	C	Piano & EP	Music Box	Jazzier	60's Organ
	D	New Age Piano	Toy Piano	Jazz Organ 2	Pump Organ
8	A	Harpsichord	Marimba	Rock Organ 2	Fr. Accordion
	B	Harpsichord2	Xylophone	Rock Organ	TangoAccordion
	C	Harpsi. Octave	Steel Drums	Drawbar Organ5	Harmonica
	D	Harpsi & Clavi	Bells	Screamin'	Kenban Harmo.

		STRINGS / VOCAL	BRASS / WIND	PAD / SYNTH	BASS / GUITAR
1	A	String Pad	Exp Brass	Pad 1	Acc. Bass
	B	Warm Strings	Exp Saxes	Pad 2	Acc. Bass&Ride
	C	Warm Strings 2	Tp&Bone&Tenor	Pad 3	Electric Bass
	D	Synth Strings	Flugel & Tenor	Saw Pad	Electric Bass2
2	A	Beautiful Str.	Brass Section	Pad 4	Finger Bass
	B	String Ens.	Synth Brass	Bowed Pad	FingerSlapBass
	C	String Ens. 2	Synth Brass 2	NoisyPad	Pick Bass
	D	Full Orchestra	Jump Brass	Sweep Pad	Fretless Bass
3	A	Small Str. Ens	Exp Trumpet	Saw Lead LP24	Synth Bass
	B	Quartet	PlungerTrumpet	Saw Lead LP12	Synth Bass 2
	C	Str. Bass Ens.	Trumpet Shake	Saw Lead HP	Rubber Bass
	D	Str. Sustain	Harmon Mute Tp	Saw Lead BP	Warm SynthBass
4	A	Pizzicato	Exp Trombone	Square Lead LP24	Exp. Nylon Gtr
	B	TremoloStrings	Lead Trombone	Square Lead LP12	Pick Nylon Gtr
	C	Str. Sforzando	PlungerTrombon	Square Lead HP	Exp Guitar
	D	Orchestra Hit	ClosedMuteBone	Square Lead BP	Exp Guitar 2
5	A	Passionate Vln	Exp Alto	Pulse Lead LP24	Rhythm Guitar
	B	Classic Violin	Lead Alto	Pulse Lead LP12	Overdrive
	C	Passionate Vc	Soft Alto	Pulse Lead HP	Distortion
	D	Classic Cello	Lead Soprano	Pulse Lead BP	Muted Electric
6	A	Choir	Exp Tenor	Polysynth	Pedal Steel
	B	Breathy Choir	Ballad Tenor	PolysynthOct	HawaiianGuitar
	C	Pop Aahs	Growl Tenor	SqrPoly	Jazz Guitar
	D	Slow Choir	Baritone Sax	Warm Lead	Jazz Guitar 2
7	A	Jazz Ensemble	Exp Flute	Oct Saw	Banjo
	B	Female Scat	Ballad Flute	Oct Pulse	Mandolin
	C	Pop Ensemble	Flute Overblow	Saw HPF	Sitar
	D	Contemp Ens.	Flute Flutter	Sqr QTc	Harp
8	A	Itopia	Oboe	Noise UpDown	Ambience Set
	B	Halo Pad	Bassoon	Noise Open	Platinum Set
	C	Halo Pad 2	Jazz Clarinet	Resonance Voice	Room Set
	D	Synth Vocals	Pan Flute	Resonance Rise	Analog Set

Rhythm Pattern List

16 Swing	
1	Funk Shuffle 1
2	Funk Shuffle 2
3	Hip Hop 1
4	Hip Hop 2
5	Hip Hop 3
6	Hip Hop 4
7	16 Shuffle 1
8	16 Shuffle 2
9	16 Shuffle 3

16 Funk	
10	Funky Beat 1
11	Funky Beat 2
12	Funky Beat 3
13	Funk 1
14	Funk 2
15	Funk 3

16 Straight	
16	Jazz Funk
17	16 Beat 1
18	16 Beat 2
19	16 Beat 3
20	16 Beat 4
21	Ride Beat 4
22	Rim Beat
23	Roll Beat
24	Light Ride 1
25	Dixie Rock

16 Latin	
26	Surdo Samba
27	Latin Groove
28	Light Samba
29	Songo
30	Samba
31	Merenge

16 Dance	
32	Funky Beat 4
33	16 Beat 5
34	Disco 1
35	Disco 2
36	Techno 1
37	Techno 2
38	Techno 3
39	Heavy Techno

16 Ballad	
40	Ballad 1
41	Ballad 2
42	Ballad 3
43	Ballad 4
44	Ballad 5
45	Light Ride 2
46	Electro Pop 1
47	Electro Pop 2
48	16 Shuffle 4

8 Ballad	
49	Slow Jam
50	50's Triplet
51	R&B Triplet

8 Straight	
52	8 Beat 1
53	8 Beat 2
54	Smooth Beat
55	Pop 1
56	Pop 2
57	Ride Beat 1
58	Ride Beat 2
59	Ride Beat 3
60	Slip Beat

8 Rock	
61	Jazz Rock
62	8 Beat 3
63	Rock Beat 1
64	Rock Beat 2
65	Rock Beat 3
66	Rock Beat 4
67	Blues/Rock
68	Heavy Beat
69	Hard Rock
70	Surf Rock
71	R&B

8 Swing	
72	Motown 1
73	Fast Shuffle
74	Motown 2
75	Country 2 Beat

Triplet	
76	Triplet Rock 1
77	Triplet Rock 2
78	Bembe
79	Rock Shuffle 1
80	Rock Shuffle 2
81	Boogie
82	Triplet 1
83	Triplet 2
84	Reggae
85	Gospel Ballad
86	Waltz

Jazz	
87	H.H. Swing
88	Ride Swing
89	Fast 4 Beat
90	Afro Cuban
91	Jazz Waltz 1
92	Jazz Waltz 2
93	5/4 Swing

8 Latin	
94	H.H. Bossa
95	Ride Bossa
96	Beguine
97	Mambo
98	Cha Cha
99	Tango
100	Habanera

EFX Categories, Types, & Parameters

1. Chorus

Variation	SUB	Parameter 1	Parameter 2	Parameter 3	Parameter 4	Parameter 5	Parameter 6	Parameter 7	Parameter 8	Parameter 9	Parameter 10
Stereo		DryWet	Speed	Depth	PreDly	Phase	LowEQ	HighEQ	-	-	-
Classic		Spread	Inten.	LowEQ	HighEQ	-	-	-	-	-	-
2-Band		DryWet	Balanc	LwrSpd	Lower	UprSpd	UprDpt	PreDly	SplitF	-	-
3-Phase		DryWet	Speed	Depth	PreDly	-	-	-	-	-	-
Wide		DryWet	Speed	Depth	PreDly	-	-	-	-	-	-
Envelope		Depth	Speed	Sens.	PreDly	Phase	-	-	-	-	-
Triangle	•	DryWet	Speed	Depth	PreDly	Phase	-	-	-	-	-
Sine	•	DryWet	Speed	Depth	PreDly	-	-	-	-	-	-

2. Flanger

Variation	SUB	Parameter 1	Parameter 2	Parameter 3	Parameter 4	Parameter 5	Parameter 6	Parameter 7	Parameter 8	Parameter 9	Parameter 10
Stereo		DryWet	Speed	Depth	F.Back	PreDly	Phase	LowEQ	HighEQ	-	-
2-Band		DryWet	Balanc	LwrSpd	Lower	UprSpd	UprDpt	F.Back	PreDly	SplitF	-
Touch		DryWet	Sens.	F.Back	PreDly	LowEQ	HighEQ	-	-	-	-
Sine	•	DryWet	Speed	Depth	F.Back	PreDly	-	-	-	-	-
Triangle	•	DryWet	Speed	Depth	F.Back	PreDly	Phase	-	-	-	-

3. Phaser

Variation	SUB	Parameter 1	Parameter 2	Parameter 3	Parameter 4	Parameter 5	Parameter 6	Parameter 7	Parameter 8	Parameter 9	Parameter 10
Warm		DryWet	Speed	Depth	Reso.	LowEQ	HighEQ	-	-	-	-
Classic		DryWet	Speed	Depth	Reso.	Manual	LowEQ	HighEQ	-	-	-
8-Stage		DryWet	Speed	Depth	Reso.	Manual	-	-	-	-	-
2-Band		DryWet	Balanc	LwrSpd	Lower	LwrMnu	UprSpd	UprDpt	UprMnu	SplitF	-
Touch		DryWet	Sens.	Reso.	Manual	LowEQ	HighEQ	-	-	-	-
St.2-Stage	•	DryWet	Speed	Depth	Manual	Phase	-	-	-	-	-

4. Wah

Variation	SUB	Parameter 1	Parameter 2	Parameter 3	Parameter 4	Parameter 5	Parameter 6	Parameter 7	Parameter 8	Parameter 9	Parameter 10
ClasiTch		DryWet	Sens.	Reso.	Manual	LowEQ	HighEQ	-	-	-	-
ClassicLfo		DryWet	Speed	Depth	Reso.	Manual	LowEQ	HighEQ	-	-	-
ClassicPdl		DryWet	Sens.	Reso.	Manual	LowEQ	HighEQ	-	-	-	-
LpfTch	•	DryWet	Sens.	Manual	-	-	-	-	-	-	-
LpfLfo	•	DryWet	Speed	Depth	Manual	-	-	-	-	-	-
LpfPdl	•	DryWet	Sens.	Manual	-	-	-	-	-	-	-

5. Tremolo

Variation	SUB	Parameter 1	Parameter 2	Parameter 3	Parameter 4	Parameter 5	Parameter 6	Parameter 7	Parameter 8	Parameter 9	Parameter 10
Classic		Depth	Speed	LowEQ	HighEQ	-	-	-	-	-	-
2-Band		Depth	Balanc	LwrSpd	UprSpd	SplitF	-	-	-	-	-
VibratoTrm		Depth	Speed	Vib.	LowEQ	HighEQ	-	-	-	-	-
Sine	•	Depth	Speed	-	-	-	-	-	-	-	-
Square	•	Depth	Speed	-	-	-	-	-	-	-	-
Saw	•	Depth	Speed	-	-	-	-	-	-	-	-

6. Auto Pan

Variation	SUB	Parameter 1	Parameter 2	Parameter 3	Parameter 4	Parameter 5	Parameter 6	Parameter 7	Parameter 8	Parameter 9	Parameter 10
Classic		Depth	Speed	LowEQ	HighEQ	-	-	-	-	-	-
2-Band		Depth	Balanc	LwrSpd	UprSpd	SplitF	-	-	-	-	-
Envelope		Depth	Speed	Sens.	-	-	-	-	-	-	-
Standard	•	Depth	Speed	-	-	-	-	-	-	-	-

7. Delay / Reverb

Variation	SUB	Parameter 1	Parameter 2	Parameter 3	Parameter 4	Parameter 5	Parameter 6	Parameter 7	Parameter 8	Parameter 9	Parameter 10
Standard		DryWet	Time	F.Back	H.Damp	-	-	-	-	-	-
PingPong		DryWet	Time	F.Back	H.Damp	-	-	-	-	-	-
LCR		DryWet	Time	F.Back	H.Damp	-	-	-	-	-	-
3-Tap		DryWet	C.Time	C.Gain	F.Back	H.Damp	L.Time	L.Gain	R.Time	RightG	-
Classic	•	DryWet	Time	F.Back	-	-	-	-	-	-	-
Short	•	DryWet	Time	F.Back	-	-	-	-	-	-	-
Ambience		DryWet	Size	H.Damp	LowEQ	HighEQ	-	-	-	-	-
EarlyRef		DryWet	Size	PreDly	LPF	LowEQ	HighEQ	-	-	-	-

8. Pitch Shift

Variation	SUB	Parameter 1	Parameter 2	Parameter 3	Parameter 4	Parameter 5	Parameter 6	Parameter 7	Parameter 8	Parameter 9	Parameter 10
Detune		DryWet	Fine	-	-	-	-	-	-	-	-
FeedBack		DryWet	Fine	Coarse	Delay	F.Back	H.Damp	-	-	-	-
Standard	•	DryWet	Fine	Coarse	-	-	-	-	-	-	-

9. Compressor

Variation	SUB	Parameter 1	Parameter 2	Parameter 3	Parameter 4	Parameter 5	Parameter 6	Parameter 7	Parameter 8	Parameter 9	Parameter 10
2-Band		Gain	Balanc	LRatio	LThrsh	LwrAtk	Releas	URatio	UThrsh	UprAtk	SplitF
Standard	•	Gain	Ratio	Trshld	Attack	Releas	-	-	-	-	-

10. Overdrive

Variation	SUB	Parameter 1	Parameter 2	Parameter 3	Parameter 4	Parameter 5	Parameter 6	Parameter 7	Parameter 8	Parameter 9	Parameter 10
Stereo		DryWet	Drive	Gain	LowEQ	HighEQ	-	-	-	-	-
Classic	•	DryWet	Drive	Gain	-	-	-	-	-	-	-
Distortion	•	DryWet	Drive	Gain	-	-	-	-	-	-	-

11. EQ / Filter

Variation	SUB	Parameter 1	Parameter 2	Parameter 3	Parameter 4	Parameter 5	Parameter 6	Parameter 7	Parameter 8	Parameter 9	Parameter 10
4-BandEQ		Gain	Low	Mid1	Mid1Q	Mid1F	High	Mid2	Mid2Q	Mid2F	-
7-BandEQ		Gain	100Hz	200Hz	400Hz	800Hz	1.6kHz	3.2kHz	6.4kHz	-	-
Standard	•	Gain	Low	Mid	High	Mid F	-	-	-	-	-
Enhancer	•	DryWet	Depth	-	-	-	-	-	-	-	-
10-PoleFlt		DryWet	Freq.	Sens.	Gain	LpfHpf	-	-	-	-	-

EFX Categories, Types, & Parameters

12. Rotary

Variation	SUB	Parameter 1	Parameter 2	Parameter 3	Parameter 4	Parameter 5	Parameter 6	Parameter 7	Parameter 8	Parameter 9	Parameter 10
Classic		Slow/Fast	LwrFastSpd	LwrSlowSpd	LwrAcc.Spd	Rot:Spread	UprFastSpd	UprSlowSpd	UprAcc.Spd	-	-
Warm		Slow/Fast	LwrFastSpd	LwrSlowSpd	LwrAcc.Spd	Rot:Spread	UprFastSpd	UprSlowSpd	UprAcc.Spd	-	-
Dirty		Slow/Fast	Rot:Depth	Rot:AccSpd	Rot:Spread	FastSpeed	SlowSpeed	Rot:LowEQ	Rot:HighEQ	Rot:Drive	Rot:Gain
+Vib/Cho		Slow/Fast	Rot:Depth	FastSpeed	SlowSpeed	Rot:AccSpd	Rot:Spread	Rot:VibCho	Rot:Mode	-	-
Single	•	Slow/Fast	Rot:Depth	FastSpeed	SlowSpeed	Rot:AccSpd	Rot:Spread	-	-	-	-

13. Groove

Variation	SUB	Parameter 1	Parameter 2	Parameter 3	Parameter 4	Parameter 5	Parameter 6	Parameter 7	Parameter 8	Parameter 9	Parameter 10
S/H Flg		Grv:DryWet	Grv:Speed	Grv:Depth	Grv:F.Back	Grv:Manual	Grv:Attack	Grv:PanDpt	-	-	-
S/H Pha		Grv:DryWet	Grv:Speed	Grv:Depth	Grv:F.Back	Grv:Manual	Grv:Attack	Grv:PanDpt	-	-	-
S/H Wah		Grv:DryWet	Grv:Speed	Grv:Depth	Grv:F.Back	Grv:Manual	Grv:Attack	Grv:PanDpt	-	-	-
S/H Pan	•	Grv:DryWet	Grv:Speed	Grv:Pan	Grv:Attack	-	-	-	-	-	-

14. Misc

Variation	SUB	Parameter 1	Parameter 2	Parameter 3	Parameter 4	Parameter 5	Parameter 6	Parameter 7	Parameter 8	Parameter 9	Parameter 10
RingMod		Mod:DryWet	Mod:Freq.	Mod:LowEQ	Mod:HighEQ	-	-	-	-	-	-
Lo-Fi		Mod:DryWet	Mod:ModSpd	Mod:ModDpt	Mod:S.Rate	Mod:Reso.	Mod:Filter	-	-	-	-

15. Chorus+

main zone only

Variation	Parameter 1	Parameter 2	Parameter 3	Parameter 4	Parameter 5	Parameter 6	Parameter 7	Parameter 8	Parameter 9	Parameter 10
Flanger	Cho:DryWet	Cho:Speed	Cho:Depth	Cho:PreDly	Cho:Phase	Flg:DryWet	Flg:Speed	Flg:Depth	Flg:F.Back	Flg:PreDly
Phaser	Cho:DryWet	Cho:Speed	Cho:Depth	Cho:PreDly	Cho:Phase	Pha:DryWet	Pha:Speed	Pha:Depth	Pha:Manual	Pha:Phase
Wah	Cho:DryWet	Cho:Speed	Cho:Depth	Cho:PreDly	Cho:Phase	Wah:DryWet	Wah:Sens.	Wah:Manual	-	-
Tremolo	Cho:DryWet	Cho:Speed	Cho:Depth	Cho:PreDly	Cho:Phase	Trm:Depth	Trm:Speed	-	-	-
AutoPan	Cho:DryWet	Cho:Speed	Cho:Depth	Cho:PreDly	Cho:Phase	Pan:Depth	Pan:Speed	-	-	-
Delay	Cho:DryWet	Cho:Speed	Cho:Depth	Cho:PreDly	Cho:Phase	Dly:DryWet	Dly:Time	Dly:F.Back	-	-

16. Phaser+

main zone only

Variation	Parameter 1	Parameter 2	Parameter 3	Parameter 4	Parameter 5	Parameter 6	Parameter 7	Parameter 8	Parameter 9	Parameter 10
Chorus	Pha:DryWet	Pha:Speed	Pha:Depth	Pha:Manual	Pha:Phase	Cho:DryWet	Cho:Speed	Cho:Depth	Cho:PreDly	Cho:Phase
Flanger	Pha:DryWet	Pha:Speed	Pha:Depth	Pha:Manual	Pha:Phase	Flg:DryWet	Flg:Speed	Flg:Depth	Flg:F.Back	Flg:PreDly
Wah	Pha:DryWet	Pha:Speed	Pha:Depth	Pha:Manual	Pha:Phase	Wah:DryWet	Wah:Sens.	Wah:Manual	-	-
Tremolo	Pha:DryWet	Pha:Speed	Pha:Depth	Pha:Manual	Pha:Phase	Trm:Depth	Trm:Speed	-	-	-
AutoPan	Pha:DryWet	Pha:Speed	Pha:Depth	Pha:Manual	Pha:Phase	Pan:Depth	Pan:Speed	-	-	-
Delay	Pha:DryWet	Pha:Speed	Pha:Depth	Pha:Manual	Pha:Phase	Dly:DryWet	Dly:Time	Dly:F.Back	-	-

17. Wah+

main zone only

Variation	Parameter 1	Parameter 2	Parameter 3	Parameter 4	Parameter 5	Parameter 6	Parameter 7	Parameter 8	Parameter 9	Parameter 10
Chorus	Wah:DryWet	Wah:Sens.	Wah:Manual	Cho:DryWet	Cho:Speed	Cho:Depth	Cho:PreDly	Cho:Phase	-	-
Flanger	Wah:DryWet	Wah:Sens.	Wah:Manual	Flg:DryWet	Flg:Speed	Flg:Depth	Flg:F.Back	Flg:PreDly	-	-
Phaser	Wah:DryWet	Wah:Sens.	Wah:Manual	Pha:DryWet	Pha:Speed	Pha:Depth	Pha:Manual	Pha:Phase	-	-
Tremolo	Wah:DryWet	Wah:Sens.	Wah:Manual	Trm:Depth	Trm:Speed	-	-	-	-	-
AutoPan	Wah:DryWet	Wah:Sens.	Wah:Manual	Pan:Depth	Pan:Speed	-	-	-	-	-
Delay	Wah:DryWet	Wah:Sens.	Wah:Manual	Dly:DryWet	Dly:Time	Dly:F.Back	-	-	-	-

18. EQ+

main zone only

Variation	Parameter 1	Parameter 2	Parameter 3	Parameter 4	Parameter 5	Parameter 6	Parameter 7	Parameter 8	Parameter 9	Parameter 10
Chorus	EQ:Gain	EQ:Low	EQ:Mid	EQ:High	EQ:Mid F	Cho:DryWet	Cho:Speed	Cho:Depth	Cho:PreDly	Cho:Phase
Flanger	EQ:Gain	EQ:Low	EQ:Mid	EQ:High	EQ:Mid F	Flg:DryWet	Flg:Speed	Flg:Depth	Flg:F.Back	Flg:PreDly
Phaser	EQ:Gain	EQ:Low	EQ:Mid	EQ:High	EQ:Mid F	Pha:DryWet	Pha:Speed	Pha:Depth	Pha:Manual	Pha:Phase
Wah	EQ:Gain	EQ:Low	EQ:Mid	EQ:High	EQ:Mid F	Wah:DryWet	Wah:Sens.	Wah:Manual	-	-
Tremolo	EQ:Gain	EQ:Low	EQ:Mid	EQ:High	EQ:Mid F	Trm:Depth	Trm:Speed	-	-	-
AutoPan	EQ:Gain	EQ:Low	EQ:Mid	EQ:High	EQ:Mid F	Pan:Depth	Pan:Speed	-	-	-
Delay	EQ:Gain	EQ:Low	EQ:Mid	EQ:High	EQ:Mid F	Dly:DryWet	Dly:Time	Dly:F.Back	-	-
Compressor	EQ:Gain	EQ:Low	EQ:Mid	EQ:High	EQ:Mid F	Cmp:Gain	Cmp:Ratio	Cmp:Thresh	Cmp:Attack	Cmp:Releas

19. Enhancer+

main zone only

Variation	Parameter 1	Parameter 2	Parameter 3	Parameter 4	Parameter 5	Parameter 6	Parameter 7	Parameter 8	Parameter 9	Parameter 10
Chorus	Enh:DryWet	Enh:Depth	Cho:DryWet	Cho:Speed	Cho:Depth	Cho:PreDly	Cho:Phase	-	-	-
Flanger	Enh:DryWet	Enh:Depth	Flg:DryWet	Flg:Speed	Flg:Depth	Flg:F.Back	Flg:PreDly	-	-	-
Phaser	Enh:DryWet	Enh:Depth	Pha:DryWet	Pha:Speed	Pha:Depth	Pha:Manual	Pha:Phase	-	-	-
Wah	Enh:DryWet	Enh:Depth	Wah:DryWet	Wah:Sens.	Wah:Manual	-	-	-	-	-
Tremolo	Enh:DryWet	Enh:Depth	Trm:Depth	Trm:Speed	-	-	-	-	-	-
AutoPan	Enh:DryWet	Enh:Depth	Pan:Depth	Pan:Speed	-	-	-	-	-	-
Delay	Enh:DryWet	Enh:Depth	Dly:DryWet	Dly:Time	Dly:F.Back	-	-	-	-	-
Compressor	Enh:DryWet	Enh:Depth	Cmp:Gain	Cmp:Ratio	Cmp:Thresh	Cmp:Attack	Cmp:Releas	-	-	-

20. Pitch Shift+

main zone only

Variation	Parameter 1	Parameter 2	Parameter 3	Parameter 4	Parameter 5	Parameter 6	Parameter 7	Parameter 8	Parameter 9	Parameter 10
Flanger	Psh:DryWet	Psh:Fine	Psh:Coarse	Flg:DryWet	Flg:Speed	Flg:Depth	Flg:F.Back	Flg:PreDly	-	-
Phaser	Psh:DryWet	Psh:Fine	Psh:Coarse	Pha:DryWet	Pha:Speed	Pha:Depth	Pha:Manual	Pha:Phase	-	-
Wah	Psh:DryWet	Psh:Fine	Psh:Coarse	Wah:DryWet	Wah:Sens.	Wah:Manual	-	-	-	-
Tremolo	Psh:DryWet	Psh:Fine	Psh:Coarse	Trm:Depth	Trm:Speed	-	-	-	-	-
AutoPan	Psh:DryWet	Psh:Fine	Psh:Coarse	Pan:Depth	Pan:Speed	-	-	-	-	-
Delay	Psh:DryWet	Psh:Fine	Psh:Coarse	Dly:DryWet	Dly:Time	Dly:F.Back	-	-	-	-

EFX Categories, Types, & Parameters

21. Compressor+

main zone only

Variation	Parameter 1	Parameter 2	Parameter 3	Parameter 4	Parameter 5	Parameter 6	Parameter 7	Parameter 8	Parameter 9	Parameter 10
Chorus	Cmp:Gain	Cmp:Ratio	Cmp:Thresh	Cmp:Attack	Cmp:Releas	Cho:DryWet	Cho:Speed	Cho:Depth	Cho:PreDly	Cho:Phase
Flanger	Cmp:Gain	Cmp:Ratio	Cmp:Thresh	Cmp:Attack	Cmp:Releas	Flg:DryWet	Flg:Speed	Flg:Depth	Flg:F.Back	Flg:PreDly
Phaser	Cmp:Gain	Cmp:Ratio	Cmp:Thresh	Cmp:Attack	Cmp:Releas	Pha:DryWet	Pha:Speed	Pha:Depth	Pha:Manual	Pha:Phase
Wah	Cmp:Gain	Cmp:Ratio	Cmp:Thresh	Cmp:Attack	Cmp:Releas	Wah:DryWet	Wah:Sens.	Wah:Manual	-	-
Tremolo	Cmp:Gain	Cmp:Ratio	Cmp:Thresh	Cmp:Attack	Cmp:Releas	Trm:Depth	Trm:Speed	-	-	-
AutoPan	Cmp:Gain	Cmp:Ratio	Cmp:Thresh	Cmp:Attack	Cmp:Releas	Pan:Depth	Pan:Speed	-	-	-
Delay	Cmp:Gain	Cmp:Ratio	Cmp:Thresh	Cmp:Attack	Cmp:Releas	Dly:DryWet	Dly:Time	Dly:F.Back	-	-
OverDrive	Cmp:Gain	Cmp:Ratio	Cmp:Thresh	Cmp:Attack	Cmp:Releas	Ovd:DryWet	Ovd:Drive	Ovd:Gain	-	-

22. Overdrive+

main zone only

Variation	Parameter 1	Parameter 2	Parameter 3	Parameter 4	Parameter 5	Parameter 6	Parameter 7	Parameter 8	Parameter 9	Parameter 10
Chorus	Ovd:DryWet	Ovd:Drive	Ovd:Gain	Cho:DryWet	Cho:Speed	Cho:Depth	Cho:PreDly	Cho:Phase	-	-
Flanger	Ovd:DryWet	Ovd:Drive	Ovd:Gain	Flg:DryWet	Flg:Speed	Flg:Depth	Flg:F.Back	Flg:PreDly	-	-
Phaser	Ovd:DryWet	Ovd:Drive	Ovd:Gain	Pha:DryWet	Pha:Speed	Pha:Depth	Pha:Manual	Pha:Phase	-	-
Wah	Ovd:DryWet	Ovd:Drive	Ovd:Gain	Wah:DryWet	Wah:Sens.	Wah:Manual	-	-	-	-
Tremolo	Ovd:DryWet	Ovd:Drive	Ovd:Gain	Trm:Depth	Trm:Speed	-	-	-	-	-
AutoPan	Ovd:DryWet	Ovd:Drive	Ovd:Gain	Pan:Depth	Pan:Speed	-	-	-	-	-
Delay	Ovd:DryWet	Ovd:Drive	Ovd:Gain	Dly:DryWet	Dly:Time	Dly:F.Back	-	-	-	-
EQ	Ovd:DryWet	Ovd:Drive	Ovd:Gain	EQ:Gain	EQ:Low	EQ:Mid	EQ:High	EQ:MidFrq	-	-

23. Parallel

main zone only

Variation	Parameter 1	Parameter 2	Parameter 3	Parameter 4	Parameter 5	Parameter 6	Parameter 7	Parameter 8	Parameter 9	Parameter 10
Cho II Flg	Cho:DryWet	Cho:Speed	Cho:Depth	Cho:PreDly	Cho:Phase	Flg:DryWet	Flg:Speed	Flg:Depth	Flg:F.Back	Flg:PreDly
Cho II Pha	Cho:DryWet	Cho:Speed	Cho:Depth	Cho:PreDly	Cho:Phase	Pha:DryWet	Pha:Speed	Pha:Depth	Pha:Manual	Pha:Phase
Cho II Wah	Cho:DryWet	Cho:Speed	Cho:Depth	Cho:PreDly	Cho:Phase	Wah:DryWet	Wah:Sens.	Wah:Manual	-	-
Cho II Trm	Cho:DryWet	Cho:Speed	Cho:Depth	Cho:PreDly	Cho:Phase	Trm:Depth	Trm:Speed	-	-	-
Cho II Pan	Cho:DryWet	Cho:Speed	Cho:Depth	Cho:PreDly	Cho:Phase	Pan:Depth	Pan:Speed	-	-	-
Cho II Dly	Cho:DryWet	Cho:Speed	Cho:Depth	Cho:PreDly	Cho:Phase	Dly:DryWet	Dly:Time	Dly:F.Back	-	-

Specifications

■ Kawai MP7SE Stage Piano

Keyboard	88 weighted keys with Ivory Touch key surfaces Responsive Hammer III (RH III) action with Let-Off, Triple Sensor, and Counterweights	
Sound Source	Harmonic Imaging™ XL (HI-XL), 88-key piano sampling	
No. of Sounds	256 voices (8 categories)	PIANO x 32, E.PIANO x 32, DRAWBAR x 32, ORGAN x 32, STRINGS/VOCAL x 32, BRASS/WIND x32, PAD/SYNTH x 32, BASS/GUITAR x 32
Polyphony	max. 256 notes	
Zones	Types:	MAIN, SUB1, SUB2, SUB3
	Modes:	INT, EXT, BOTH
Reverb	Types:	6 types (Room, Lounge, Small Hall, Concert Hall, Live Hall, Cathedral)
	Parameters:	PreDelay, Reverb Time, Reverb Depth
Effects	Types:	129 types (MAIN zone), 22 types (SUB zones)
	Parameters:	Up to 10 parameters, depending on effect type
	Modules:	MAIN zone: EFX1, EFX2 SUB zones: EFX
Amp Simulator <small>MAIN ZONE ONLY</small>	Types:	5 types (S. Case, M. Stack, J. Combo, F. Bass, L. Cabi)
	Parameters:	Drive, Level, Amp EQ Lo, Amp EQ Mid, Amp EQ Hi, Mid Frequency, Mic Type, Mic Position, Ambience
Tonewheel Organ <small>MAIN ZONE ONLY</small>	Drawbars:	16', 5 1/2', 8', 4', 2 3/4', 2', 1 3/4', 1 1/2', 1' (real-time adjustable by panel faders/knobs and MIDI)
	Percussion:	Off/On, Normal/Soft, Slow/Fast, 2nd/3rd
Virtual Technician	Touch Curve:	6 types (Light+, Light, Normal, Heavy, Heavy+, Off), User1~5
	Parameters:	PIANO: Voicing, String Resonance, Undamped Resonance, Damper Resonance, Key-off Effect, Damper Noise, Hammer Delay, Fall-back Noise, Topboard, Stereo Width E.PIANO/HARPSI/BASS: Key-off Noise, Key-off Delay DRAWBAR: Key Click Level, Wheel Noise Level
	Temperament & Tuning:	7 types (Equal, Pure Major/Minor, Pythagorean, Meantone, Werkmeister, Kirnberger), User1~2 Fine Tune, Stretch Tuning, Key of Temperament
EQ	4-band equaliser (Low Gain, Mid1 Gain, Mid1 Q, Mid1 Freq., Mid2 Gain, Mid2 Q, Mid2 Freq., High Gain)	
Recorder	Internal:	10 songs – approximately 90,000 note memory capacity Transpose song, Convert song to Audio, Load SMF, Save SMF
	Audio:	Play MP3/WAV, Save MP3/WAV, Overdub, Recorder Gain
Metronome	Click:	1/4, 2/4, 3/4, 4/4, 5/4, 3/8, 6/8, 7/8, 9/8, 12/8
	Rhythm:	100 drum patterns
Internal Memories	SOUND:	256 memories (8 x 8 x 4)
	SETUP:	256 memories (8 x 8 x 4)
	POWERON:	1 memory
USB Functions	Load/Save:	One Sound, One Setup, SMF, All Sound, All Setup, All Backup
	Others:	Delete, Rename, Format
EDIT Menu	INT mode:	116 parameters (Reverb, EFX/AMP, Sound, Tuning, Key Setup, Controllers, Knob Assign, Virtual Tech.)
	EXT mode:	64 parameters (Channel/Program, SETUP, Transmit, MMC, Key Setup, Controllers, Knob Assign)
SYSTEM Menu	52 parameters and functions (Utility, Pedal, MIDI, Offset, User Edit, Reset)	
Display	128 x 64 pixel LCD with backlight	
Panel Controls	Pitch Bend, Modulation, SW1, SW2, Volume, Line In, Zone Mixer, Control Knobs A~D (assignable), MMC	
Jacks	Output:	1/4" LINE OUT (L/MONO, R), Headphones
	Input:	1/4" LINE IN (L/MONO, R)
	MIDI & USB:	MIDI IN, MIDI OUT, MIDI THRU, USB to Host, USB to Device
	Foot Control:	DAMPER (for F-10H), DAMPER/SOSTENUTO/SOFT (for GFP-3), FSW, EXP with EXP TYPE switch
	Power:	AC IN
Power Consumption	20 W	
Dimensions	1362 (W) x 339 (D) x 172 (H) mm / 53 5/8" (W) x 13 1/2" (D) x 6 3/4" (H)	
Weight	22.5 kg / 49.6 lbs.	
Included Accessories	F-10H pedal unit (with half-damper support), Music rest, Power cable, Owner's manual	

Specifications are subject to change without notice.

1. Recognised data

- 1.1 Channel Voice Message
- 1.2 Channel Mode Message
- 1.3 System Realtime Message

2. Transmitted data

- 2.1 Channel Voice Message
- 2.2 Channel Mode Message
- 2.3 System Realtime Message

3. Exclusive data

- 3.1 MMC Commands
- 3.2 Parameter Send
- 3.3 Setup Parameters: Global Section
- 3.4 Setup Parameters: EDIT Menu
- 3.5 Setup Parameters: SYSTEM Menu
- 3.6 Assignable Knob Parameters

4. SOUND/SETUP Program/Bank

- 4.1 SETUP Program Number Table

5. Program Change Number List

6. Control Change Number (CC#) Table

MIDI Implementation Chart

1 Recognised Data

1.1 Channel Voice Message

Note off

Status	2nd Byte	3rd Byte
8nH	kkH	vvH
9nH	kkH	00H
n=MIDI channel number		:0H-fH(ch.1 ~ ch.16)
kk=Note Number		:00H - 7fH(0 ~ 127)
vv=Velocity		:00H - 7fH(0 ~ 127)

Note on

Status	2nd Byte	3rd Byte
9nH	kkH	vvH
n=MIDI channel number		:0H-fH(ch.1 ~ ch.16)
kk=Note Number		:00H - 7fH(0 ~ 127)
vv=Velocity		:00H - 7fH(0 ~ 127)

Control Change Bank Select (MSB)

Status	2nd Byte	3rd Byte
BnH	00H	mmH
BnH	20H	llH
n=MIDI channel number		:0H-fH(ch.1 ~ ch.16)
mm = Bank Number MSB		:00H-7fH (0 ~ 127)
ll = BankNumber LSB		:00H-7fH (0 ~ 127)

Modulation

Status	2nd Byte	3rd Byte
BnH	01H	vvH
n=MIDI channel number		:0H-fH(ch.1 ~ ch.16)
vv = Modulation depth		:00H - 7fH(0 ~ 127) Default = 00H

Data Entry

Status	2nd Byte	3rd Byte
BnH	06H	mmH
BnH	26H	llH
n=MIDI channel number		:0H-fH(ch.1 ~ ch.16)
mm,ll=Value indicated in RPN/NRPN *see RPN/NRPN chapter		:00H - 7fH(0 ~ 127)

Volume

Status	2nd Byte	3rd Byte
BnH	07H	vvH
n=MIDI channel number		:0H-fH(ch.1 ~ ch.16)
vv=Volume		:00H - 7fH(0 ~ 127) Default = 7fH

Panpot

Status	2nd Byte	3rd Byte
BnH	0aH	vvH
n=MIDI channel number		:0H-fH(ch.1 - ch.16)
vv=Panpot		:00H - 40H - 7fH(left ~centre~right) Default = 40H(centre)

1.1 Channel Voice Message (cont.)

Expression			
Status	2nd Byte	3rd Byte	
BnH	0bH	vvH	
n=MIDI channel number		:0H-fH(ch.1 ~ ch.16)	
vv=Expression		:00H - 7fH(0 ~ 127)	Default = 7fH
Damper Pedal			
Status	2nd Byte	3rd Byte	
BnH	40H	vvH	
n=MIDI channel number		:0H-fH(ch.1 ~ ch.16)	
vv=Control Value		:00H - 7fH(0 ~ 127)	Default = 00H
0 - 63=OFF, 64 - 127=ON			
Sostenuto Pedal			
Status	2nd Byte	3rd Byte	
BnH	42H	vvH	
n=MIDI channel number		:0H-fH(ch.1 ~ ch.16)	
vv=Control Value		:00H - 7fH(0 ~ 127)	Default = 00H
0 - 63 =OFF, 64 - 127=ON			
Soft Pedal			
Status	2nd Byte	3rd Byte	
BnH	43H	vvH	
n=MIDI channel number		:0H-fH(ch.1 ~ ch.16)	
vv=Control Value		:00H - 7fH(0 ~ 127)	Default = 00H
0 - 63 =OFF, 64 - 127=ON			
Sound controllers #1-9			
Status	2nd Byte	3rd Byte	
BnH	46H	vvH	Sustain Level
BnH	47H	vvH	Resonance
BnH	48H	vvH	Release time
BnH	49H	vvH	Attack time
BnH	4aH	vvH	Cutoff
BnH	4bH	vvH	Decay time
BnH	4cH	vvH	Vibrato Rate
BnH	4dH	vvH	Vibrato Depth
BnH	4eH	vvH	Vibrato Delay
n=MIDI channel number		:0H-fH(ch.1 ~ ch.16)	
vv=Control Value		:00H - 7fH(-64 ~ 0 ~ +63)	Default = 40H
Effect Control			
Status	2nd Byte	3rd Byte	
BnH	5bH	vvH	Reverb depth
n=MIDI channel number		:0H-fH(ch.1 ~ ch.16)	
vv = Control Value		:00H - 7fH(0 ~ 127)	

1.1 Channel Voice Message (cont.)

RPN MSB/LSB

Status	2nd Byte	3rd Byte
BnH	63H	mmH
BnH	62H	llH
n=MIDI channel number		:0H-fH(ch.1 ~ ch.16)
mm=MSB of the NRPN parameter number		
ll=LSB of the NRPN parameter number		

NRPN numbers implemented in MP7SE are as follows

NRPN # Data

MSB	LSB	MSB	Function & Range	Default
01H	08H	mmH	Vibrato Rate mm:00H - 7FH(-64 ~ 0 ~ +63)	Default = 40H
01H	09H	mmH	Vibrato Depth mm :00H - 7FH(-64 ~ 0 ~ +63)	Default = 40H
01H	0aH	mmH	Vibrato Delay mm :00H - 7FH(-64 ~ 0 ~ +63)	Default = 40H
01H	20H	mmH	Cutoff mm :00H - 7FH(-64 ~ 0 ~ +63)	Default = 40H
01H	21H	mmH	Resonance mm :00H - 7FH(-64 ~ 0 ~ +63)	Default = 40H
01H	63H	mmH	Attack time mm :00H - 7FH(-64 ~ 0 ~ +63)	Default = 40H
01H	64H	mmH	Decay time mm :00H - 7FH(-64 ~ 0 ~ +63)	Default = 40H
01H	66H	mmH	Release time mm :00H - 7FH(-64 ~ 0 ~ +63)	Default = 40H

* Ignoring the LSB of data Entry

* It is not affected in case of modifying cutoff if tone does not use the DCF.

RPN MSB/LSB

Status	2nd Byte	3rd Byte
BnH	65H	mmH
BnH	64H	llH
n=MIDI channel number		:0H-fH(ch.1 ~ ch.16)

mm=MSB of the RPN parameter number

ll=LSB of the RPN parameter number

RPN number implemented in MP7SE are the followings

RPN # Data

MSB	LSB	MSB	LSB	Function & Range	Default
00H	00H	mmH	llH	Pitch bend sensitivity mm :00H-0cH (0~12 [half tone]),ll:00H	Default = 02H
00H	01H	mmH	llH	Master fine tuning mm,ll :20 00H - 40 00H - 60 00H (-8192x50/8192 ~ 0 ~ +8192x50/8192 [cents])	
00H	05H	mmH	llH	Modulation Depth Range mm,ll :00 00H - 06 00H (0~600[cents])	Default = 00H/40H (+/-50 cents)
7fH	7fH	--	--	RPN NULL	

Program Change

Status	2nd Byte
CnH	ppH

n=MIDI channel number :0H-fH(ch.1 ~ ch.16)

pp=Program number :00H - 7fH(0 ~ 127) Default = 00H

Pitch Bend Change

Status	2nd Byte	3rd Byte
EnH	llH	mmH

n=MIDI channel number :0H-fH(ch.1 ~ ch.16)

mm,ll=Pitch bend value :00 00-7f 7fH(-8192~0~+8192) Default = 40 00H

1.2 Channel Mode Message

All Sound OFF

Status	2nd Byte	3rd Byte
BnH	78H	00H
n=MIDI channel number		:0H-fH(ch.1 ~ ch.16)

Reset All Controller

Status	2nd Byte	3rd Byte
BnH	79H	00H
n=MIDI channel number		:0H-fH(ch.1 ~ ch.16)

All Note Off

Status	2nd Byte	3rd Byte
BnH	7bH	00H
n=MIDI channel number		:0H-fH(ch.1 ~ ch.16)

1.3 System Realtime Message

Status	
FEH	Active sensing

2 Transmitted Data

2.1 Channel Voice Message

Note off

Status	2nd Byte	3rd Byte
8nH	kkH	vvH
n=MIDI channel number		:0H-fH(ch.1 ~ ch.16)
kk=Note Number		:00H - 7fH(0 ~ 127)
vv=Velocity		:00H - 7fH(0 ~ 127)

Note on

Status	2nd Byte	3rd Byte
9nH	kkH	vvH
n=MIDI channel number		:0H-fH(ch.1 ~ ch.16)
kk=Note Number		:00H - 7fH(0 ~ 127)
vv=Velocity		:00H - 7fH(0 ~ 127)

Control Change

Status	2nd Byte	3rd Byte
BnH	ccH	vvH

* Sending by Assignable Control Knobs

Program Change

Status	2nd Byte	
CnH	ppH	
n=MIDI channel number		:0H-fH(ch.1 ~ ch.16)
pp=Program number		:00H - 7fH(0 ~ 127) Default = 00H

After Touch

Status	2nd Byte	
DnH	ppH	
n=MIDI channel number		:0H-fH(ch.1 ~ ch.16)
pp=Value		
*Sending only when Controller or Knob=AfterTouch		

Pitch Bend Change

Status	2nd Byte	3rd Byte
EnH	llH	mmH
n=MIDI channel number		:0H-fH(ch.1 ~ ch.16)
mm,ll=Pitch bend value		:00 00-7f 7fH(-8192~-0~+8192) Default = 40 00H

2.2 Channel Mode Message

Reset All Controller

Status	2nd Byte	3rd Byte
BnH	79H	00H

n = MIDI channel number :0H-fH(ch.1 ~ ch.16)
*Sending by [PANIC] function

All Note Off

Status	2nd Byte	3rd Byte
BnH	7bH	00H

n = MIDI channel number :0H-fH(ch.1 ~ ch.16)
*Sending by [PANIC] function

MONO

Status	2nd Byte	3rd Byte
BnH	7eH	mmH

n=MIDI channel number :0H-fH(ch.1 ~ ch.16)
mm=mono number :01H(M=1)

POLY

Status	2nd Byte	3rd Byte
BnH	7fH	00H

n=MIDI channel number :0H-fH(ch.1 ~ ch.16)

2.3 System Realtime Message

Status

FAH	Start
FBH	Continue
FCH	Stop

*Sending by [RECORDER CONTROL] buttons

3 Exclusive Data

3.1 MMC Commands

No.	Description	Value	Notes
1	Exclusive	F0H	
2	Universal Real Time	7FH	
3	Device ID	0-7FH	
4	MMC command	06H	
5	Command Number	01-0DH	* see table right
6	EOX	F7H	

*Sending by [RECORDER CONTROL] buttons

*Transmit only

MMC Commands			
01	STOP	08	RECORD PAUSE
02	PLAY	09	PAUSE
03	DEFERRED PLAY	0A	EJECT
04	FAST FORWARD	0B	CHASE
05	REWIND	0C	COMMAND ERROR RESET
06	RECORD STROBE	0D	MMC RESET
07	RECORD EXIT		

3.2 Parameter Send

No.	Description	Value	Notes
1	Exclusive	F0H	
2	KAWAI ID	40H	
3	Channel no.	0-0FH,7FH	System Channel = 0-FH, Global = 7FH
4	Function no.	10H	Parameter Send
5	Group no.	00H	MI Group ID
6	Machine no.	13H	Machine ID
7	data1	50-5FH	Command ID
8	data2	0-7FH	Sub Command ID
9	data3	0-7FH	Part number (System = 7FH)
10	data4~	0-7FH	data max 18byte
	EOX	F7H	

Part number :

	MP7SE *pp=00~07
00H	INT1 (MAIN)
01H	INT2 (SUB1)
02H	INT3 (SUB3)
03H	INT4 (SUB3)
04H	EXT1 (MAIN)
05H	EXT2 (SUB1)
06H	EXT3 (SUB2)
07H	EXT4 (SUB3)
08H	-reserved-
09H	INT-COMMON
0AH	EXT-COMMON
7FH	SYSTEM/COMMON

3.3 Setup Parameters: Global Section

Category	Parameter	Com.	Sub.	Part	Byte	Value (HEX)
SETUP	Setup Mode On/Off	51	04	7F	1	00, 01 (Off, On)
	SETUP Bank/Variation	51	05	7F	2	Bank=00~3F (1-1~8-8) /Vari.=00~03 (A~D)
GLOBAL	Global EQ Switch	51	10	7F	1	00, 01 (Off, On)
	Global EQ Low Gain	51	11	7F	1	36~40~4A (-10 ~ +0 ~ +10dB)
	Global EQ High Gain	51	12	7F	1	36~40~4A (-10 ~ +0 ~ +10dB)
	Global EQ Mid1 Gain	51	13	7F	1	36~40~4A (-10 ~ +0 ~ +10dB)
	Global EQ Mid2 Gain	51	14	7F	1	36~40~4A (-10 ~ +0 ~ +10dB)
	Global EQ Mid1 Q	51	17	7F	1	00~06 (0.5~4.0)
	Global EQ Mid2 Q	51	18	7F	1	00~06 (0.5~4.0)
	Global EQ Mid1 Frequency	51	15	7F	1	00~7F (200~3150Hz)
	Global EQ Mid2 Frequency	51	16	7F	1	00~7F (200~3150Hz)
	Transpose Switch	53	01	7F	1	00, 01 (Off, On)
	Transpose Value	53	02	7F	1	28~40~58 (-24~-0~+24)
	LocalOff	58	01	7F	1	00, 01 (LocalOff, LocalOn)
	Metronome Mode	56	0A	7F	1	00, 01 (Click, Rhythm)
	Metronome Beat	56	02	7F	2	01~16 (Beat) /01, 02, 03, 04 (Measure: 1/2, 1/4, 1/8, 1/16)
	Metronome Volume	56	03	7F	1	00~7F (0~127)
	Metronome Tempo	56	01	7F	2	TempoMSB/TempoLSB=00/1E~02/2C (30~300)
	Rhythm Category	56	09	7F	1	Rhythm Pattern=00~63(1~100)
	Rhythm Variation	56	09	7F	1	Rhythm Pattern=00~63(1~100)

3.4 Setup Parameters: EDIT Menu

Category	Parameter	Com.	Sub.	Part	Byte	Value (HEX)
Buttons	Part Switch	55	06	pp	1	00, 01 (Off, On)
	Volume Fader	55	01	pp	1	00~7F
	Tone Number	55	00	pp	3	msb/lb/prog (*GM mode Program Change)
1.REVERB	REVERB Switch	55	07	pp	1	00, 01 (Off, On)
	Reverb Type	55	08	7F	1	00~05 (Room, Lounge, Small Hall, Concert Hall, LiveHall, Catedral)
	Reverb Pre Delay	55	0A	7F	1	00~7F
	Reverb Time	55	09	7F	1	00~7F
	REVERB DEPTH	55	03	pp	1	00~7F
2.EFX/AMP	EFX Switch	55	05	pp	1	00, 01 (Off, On)
	EFX Category	55	11	pp	2	Category=00~16/Type=depend on Category
	EFX Type	55	11	pp	2	Category=00~16/Type=depend on Category
	EFX Parameter 1	55	12	pp	1	0~7F (depend on EFX Type)
	EFX Parameter 2	55	13	pp	1	0~7F (depend on EFX Type)
	EFX Parameter 3	55	14	pp	1	0~7F (depend on EFX Type)
	EFX Parameter 4	55	15	pp	1	0~7F (depend on EFX Type)
	EFX Parameter 5	55	16	pp	1	0~7F (depend on EFX Type)
	EFX Parameter 6	55	17	pp	1	0~7F (depend on EFX Type)
	EFX Parameter 7	55	18	pp	1	0~7F (depend on EFX Type)
	EFX Parameter 8	55	19	pp	1	0~7F (depend on EFX Type)
	EFX Parameter 9	55	1A	pp	1	0~7F (depend on EFX Type)
	EFX Parameter 10	55	1B	pp	1	0~7F (depend on EFX Type)
	EFX2 Switch	55	20	pp	1	0, 1 (Off, On)
	EFX2 Category	55	21	pp	2	Category=00~16/Type=depend on Category
	EFX2 Type	55	21	pp	2	Category=00~16/Type=depend on Category
	EFX2 Parameter 1	55	22	pp	1	0~7F (depend on EFX Type)
	EFX2 Parameter 2	55	23	pp	1	0~7F (depend on EFX Type)
	EFX2 Parameter 3	55	24	pp	1	0~7F (depend on EFX Type)
	EFX2 Parameter 4	55	25	pp	1	0~7F (depend on EFX Type)
	EFX2 Parameter 5	55	26	pp	1	0~7F (depend on EFX Type)
	EFX2 Parameter 6	55	27	pp	1	0~7F (depend on EFX Type)
	EFX2 Parameter 7	55	28	pp	1	0~7F (depend on EFX Type)
	EFX2 Parameter 8	55	29	pp	1	0~7F (depend on EFX Type)
	EFX2 Parameter 9	55	2A	pp	1	0~7F (depend on EFX Type)
	EFX2 Parameter 10	55	2B	pp	1	0~7F (depend on EFX Type)
	AMP Simulator Switch	55	30	pp	1	0, 1 (Off, On)
	AMP Simulator Type	55	31	pp	2	Type=0~4 (S.Case, M.Stack, J.Combo, F.Bass, L.Cabi) / Vari.=0 (ignote)
	AMP Simulator Drive	55	32	pp	1	0~7F
	AMP Simulator Level	55	33	pp	1	0~7F
	AMP Simulator EQ Low	55	34	pp	1	00~0A~14 (-10 ~ +0 ~ +10dB)
	AMP Simulator EQ Mid	55	36	pp	1	00~0A~14 (-10 ~ +0 ~ +10dB)
	AMP Simulator EQ Mid Freq.	55	37	pp	1	0~7F (200~3150Hz)
	AMP Simulator EQ High	55	35	pp	1	00~0A~14 (-10 ~ +0 ~ +10dB)
	AMP Simulator Mic Type	55	38	pp	1	00, 01 (Condenser, Dynamic)
	AMP Simulator Mic Position	55	39	pp	1	00, 01 (OnAxis, OffAxis)
AMP Simulator Ambiance Level	55	3A	pp	1	0~7F	

3.4 Setup Parameters: EDIT Menu (cont.)

Category	Parameter	Com.	Sub.	Part	Byte	Value (HEX)
3.Sound	Master Volume	55	01	7F	1	0~7F
	Panpot	55	02	pp	1	0~40~7F (L64~0~R63)
	Cutoff	55	40	pp	1	0~40~7F (-64~0~+63)
	Resonance	55	41	pp	1	0~40~7F (-64~0~+63)
	DCA Attack Time	55	42	pp	1	0~40~7F (-64~0~+63)
	DCA Decay Time	55	43	pp	1	0~40~7F (-64~0~+63)
	DCA Sustain Level	55	44	pp	1	0~40~7F (-64~0~+63)
	DCA Release Time	55	45	pp	1	0~40~7F (-64~0~+63)
	DCF Attack Time	55	46	pp	1	0~40~7F (-64~0~+63)
	DCF Attack Level	55	5B	pp	1	0~40~7F (-64~0~+63)
	DCF Decay Time	55	47	pp	1	0~40~7F (-64~0~+63)
	DCF Sustain Level	55	48	pp	1	0~40~7F (-64~0~+63)
	DCF Release Time	55	49	pp	1	0~40~7F (-64~0~+63)
	DCF Touch Depth	55	4A	pp	1	0~40~7F (-64~0~+63)
	DCA Touch Depth	55	4B	pp	1	0~40~7F (-64~0~+63)
	Vibrato Depth	55	4C	pp	1	0~40~7F (-64~0~+63)
	Vibrato Rate	55	4D	pp	1	0~40~7F (-64~0~+63)
	Vibrato Delay	55	4E	pp	1	0~40~7F (-64~0~+63)
	Octave Layer On/Off	55	54	pp	1	00, 01 (Off, On)
	Octave Layer Level	55	55	pp	1	0~7F
	Octave Layer Range	55	56	pp	1	3D~40~43 (-3 ~ +0 ~ +3)
	Octave Layer Detune	55	57	pp	1	0~40~7F (-64~0~+63)
	Portament SW	55	51	pp	1	00, 01 (Off, On)
	Portament Time	55	52	pp	1	0~7F
	Portament Mode	55	53	pp	1	00, 01 (Rate, Equal)
	Drawbar 16" Level	59	01	pp	1	00~08 (0~8)
	Drawbar 5 1/3" Level	59	02	pp	1	00~08 (0~8)
	Drawbar 8" Level	59	03	pp	1	00~08 (0~8)
	Drawbar 4" Level	59	04	pp	1	00~08 (0~8)
	Drawbar 2 2/3" Level	59	05	pp	1	00~08 (0~8)
	Drawbar 2" Level	59	06	pp	1	00~08 (0~8)
	Drawbar 1 3/5" Level	59	07	pp	1	00~08 (0~8)
	Drawbar 1 1/3" Level	59	08	pp	1	00~08 (0~8)
	Drawbar 1" Level	59	09	pp	1	00~08 (0~8)
	Percuss On/Off	59	0A	pp	1	00, 01 (Off, On)
	Percuss Level	59	0B	pp	1	00, 01 (Normal, Soft)
	Percuss Decay	59	0C	pp	1	00, 01 (Slow, Fast)
	Percuss Harmonic	59	0D	pp	1	00, 01 (2nd, 3rd)
	Drawbar External Control	59	14	7F	1	00~02 (Off, MIDI CC#, MIDICH)
	Drawbar 16" RX CC#	59	15	7F	1	00~77 (0~119)
	Drawbar 5 1/3" RX CC#	59	16	7F	1	00~77 (0~119)
	Drawbar 8" RX CC#	59	17	7F	1	00~77 (0~119)
Drawbar 4" RX CC#	59	18	7F	1	00~77 (0~119)	
Drawbar 2 2/3" RX CC#	59	19	7F	1	00~77 (0~119)	
Drawbar 2" RX CC#	59	1A	7F	1	00~77 (0~119)	
Drawbar 1 3/5" RX CC#	59	1B	7F	1	00~77 (0~119)	
Drawbar 1 1/3" RX CC#	59	1C	7F	1	00~77 (0~119)	

3.4 Setup Parameters: EDIT Menu (cont.)

Category	Parameter	Com.	Sub.	Part	Byte	Value (HEX)
3.Sound	Drawbar 1" RX CC#	59	1D	7F	1	00~77 (0~119)
	Drawbar Common RX CC#	59	27	7F	1	00~77 (0~119)
	Drawbar 16" RX MIDI Ch	59	1E	7F	1	00~0F (1~16Ch.)
	Drawbar 5 1/3" RX MIDI Ch	59	1F	7F	1	00~0F (1~16Ch.)
	Drawbar 8" RX MIDI Ch	59	20	7F	1	00~0F (1~16Ch.)
	Drawbar 4" RX MIDI Ch	59	21	7F	1	00~0F (1~16Ch.)
	Drawbar 2 2/3" RX MIDI Ch	59	22	7F	1	00~0F (1~16Ch.)
	Drawbar 2" RX MIDI Ch	59	23	7F	1	00~0F (1~16Ch.)
	Drawbar 1 3/5" RX MIDI Ch	59	24	7F	1	00~0F (1~16Ch.)
	Drawbar 1 1/3" RX MIDI Ch	59	25	7F	1	00~0F (1~16Ch.)
	Drawbar 1" RX MIDI Ch	59	26	7F	1	00~0F (1~16Ch.)
4.Tuning	Fine Tune	50	22	pp	1	0~40~7F (-64~0~+63)
	Stretch Tuning	50	0B	pp	1	00~08, 40~44 (Off, Narrow2, Narrow1, Normal, Wide1, Wide2~5, Sys.User1~5)
	User Stretch Tuning	50	0C	7F	14	User#=00~04/Octave# (n)=00~08/Data (Cn~Bn, 12byte)=0E~40~72 (-50~0~+50cent)
	Temperament	50	0D	pp	2	Type=00~06, 40~41 (Equal, PureMaj~min, Pytagor, Meantone, Werkmeis, Kirnberg, Sys.User1~2) /Key=00~0B (C~B)
	Temperament Key					
User Temperament	50	0E	7F	13	User#=00~01/Data (C~B, 12byte) =0E~40~72 (-50~0~+50cent)	
5.KeySetup	Touch Curve	50	00	pp	1	00~0A (Light, Normal, Heavy, Off, Light+, Heavy+, Sys.User1~5)
	User Touch Curve	50	18	7F	18	User#=00~04/Packet# (n)=00~07/Data (vb[0+16n]~vb[15+16n], 16byte) =00~7F (*Velocity/127)
	Dynamics	53	05	pp	1	00, 01~0A (Off, 1~10)
	Trigger Mode	50	23	pp	1	00,01 (Normal, Fast)
	Minimum Touch	50	0A	pp	1	01~14 (1~20)
	Transmit	58	09	pp	2	Mode=00 (Keyboard&Panel) /Value=00, 01 (Off, On)
	Octave Shift	53	03	pp	1	3D~40~43 (-3~0~+3)
	Zone Transpose	53	02	pp	1	34~40~4C (-12~0~+12)
	KS-Damping	53	0B	pp	1	00, 01 (Off, On)
	KS-Key	53	0C	pp	1	15~6C (A0~C8)
	Key Range - Zone Low	53	08	pp	2	Low=15~6C (A0~C8) /High=15~6C (A0~C8)
	Key Range - Zone High					
	Velo SW	53	09	pp	1	00~02 (Off, Soft, Loud)
	Velo SW Value	53	0A	pp	1	00~7F
	Solo On/Off	55	4F	pp	1	00, 01 (Off, On)
	Solo Mode	55	50	pp	1	00~02 (Last, High, Low)
Key Volume	50	0F	pp	1	00~04, 40~44 (Off, HighDamping, LowDamping, High&LowDamping, CenterDamping, Sys.User1~5)	
User Key Volume	50	10	pp	14	User#=00~04/Octave# (n)=00~08/Data (Cn~Bn, 12byte)=00~40~127 (-6~0~+6dB)	
6.Control	Damper Pedal On/Off	54	04	pp	2	Cont.ID=00 (Main Damper) /Value=00, 01 (Off, On)
	Damper Pedal Assign	54	05	INT/ EXT	3	Cont.ID=00 (Main Damper) /Func.ID MSB/Func.ID LSB *(<INT>00/00~00/1B, <EXT>00/00~00/78)
	Damper Mode	50	20	pp	1	00, 01 (Normal, Hold)
	Half Pedal Value	58	0D	pp	1	00~04 (Normal, High, Low, MidHigh, MidLow)
	PitchBend Wheel On/Off	54	04	pp	2	Cont.ID=09 (Wheel1<Bender>) /Value=00, 01 (Off, On)
	PitchBend Range	55	5C	pp	1	[INT] 00~07, [EXT] 00-12

3.4 Setup Parameters: EDIT Menu (cont.)

Category	Parameter	Com.	Sub.	Part	Byte	Value (HEX)
6.Control	Soft Pedal Adjust	50	12	pp	1	01-0A
	Modulation Wheel On/Off	54	04	pp	2	Cont.ID=0A (Wheel2<Mod.>) /Value=00~02 (Off, On, Reverse)
	Modulation Wheel Assign	54	05	pp	3	Cont.ID=0A (Wheel2<Mod.>) /Func.ID MSB/Func.ID LSB *<INT>00/00~00/1B, <EXT>00/00~00/78
	Modulation Depth Range	55	5D	pp	1	00~7F
	SW1 On/Off	54	04	pp	2	Cont.ID=0B (SW1) /Value=00, 01 (Off, On)
	SW1 Assign	54	05	7F	3	Cont.ID=0B (SW1) /Func.ID MSB/Func.ID LSB **00/00~00/09
	SW2 On/Off	54	04	pp	2	Cont.ID=0C (SW2) /Value=00, 01 (Off, On)
	SW2 Assign	54	05	7F	3	Cont.ID=0C (SW2) /Func.ID MSB / Func.ID LSB **00/00~00/09
	FSW Pedal On/Off	54	04	pp	2	Cont.ID=05 (FSW1) /Value=00, 01 (Off, On)
	FSW Pedal Assign	54	05	INT/ EXT	3	Cont.ID=05 (FSW1) /Func.ID MSB/Func.ID LSB *<INT>00/00~00/1B, <EXT>00/00~00/78
	EXP Pedal On/Off	54	04	pp	2	Cont.ID=07 (EXP1) /Value=00~02 (Off, On, Reverse)
	EXP Pedal Assign	54	05	INT/ EXT	3	Cont.ID=07 (EXP1) /Func.ID MSB/Func.ID LSB *<INT>00/00~00/1B, <EXT>00/00~00/78
	Right Pedal On/Off	54	04	pp	2	Cont.ID=01 (Sub Damper) /Value=00, 01 (Off, On)
	Right Pedal Assign	54	05	INT/ EXT	3	Cont.ID=01 (Sub Damper) /Func.ID MSB/Func.ID LSB *<INT>00/00~00/1B, <EXT>00/00~00/78
	Center Pedal On/Off	54	04	pp	2	Cont.ID=03 (Sostenuto) /Value=00, 01 (Off, On)
	Center Pedal Assign	54	05	INT/ EXT	3	Cont.ID=03 (Sostenuto) /Func.ID MSB/Func.ID LSB *<INT>00/00~00/1B, <EXT>00/00~00/78
Left Pedal On/Off	54	04	pp	2	Cont.ID=04 (Soft) /Value=00, 01 (Off, On)	
Left Pedal Assign	54	05	INT/ EXT	3	Cont.ID=04 (Soft) /Func.ID MSB/Func.ID LSB *<INT>00/00~00/1B, <EXT>00/00~00/78	
7.KnobAsgn	KnobA Assign (1/2)	54	03	pp	3	Knob ID=00/Para.ID MSB/Para.ID LSB see 3.6 Assignable Knob Paraemters
	KnobB Assign (1/2)	54	03	pp	3	Knob ID=01/Para.ID MSB/Para.ID LSB see 3.6 Assignable Knob Paraemters
	KnobC Assign (1/2)	54	03	pp	3	Knob ID=02/Para.ID MSB/Para.ID LSB see 3.6 Assignable Knob Paraemters
	KnobD Assign (1/2)	54	03	pp	3	Knob ID=03/Para.ID MSB/Para.ID LSB see 3.6 Assignable Knob Paraemters
	KnobA Assign (2/2)	54	03	pp	3	Knob ID=04/Para.ID MSB/Para.ID LSB see 3.6 Assignable Knob Paraemters
	KnobB Assign (2/2)	54	03	pp	3	Knob ID=05/Para.ID MSB/Para.ID LSB see 3.6 Assignable Knob Paraemters
	KnobC Assign (2/2)	54	03	pp	3	Knob ID=06/Para.ID MSB/Para.ID LSB see 3.6 Assignable Knob Paraemters
	KnobD Assign (2/2)	54	03	pp	3	Knob ID=07/Para.ID MSB/Para.ID LSB see 3.6 Assignable Knob Paraemters
8.VirtTech	Voicing	50	01	pp	1	00~0A (Normal, Mellow1, Mellow2, Dynamic, Bright1, Bright2, Sys.User1 ~5)
	User Voicing	50	17	7F	14	User#=00~04/Octave# (n)=00~08/Data (Cn~Bn, 12byte)=3B~40~45 (-5~0~+5)
	String Resonance	50	04	pp	1	00, 01~0A (Off, 1~10)
	Undamped Resonance	50	15	pp	1	00, 01~0A (Off, 1~10)
	Damper Resonance	50	02	pp	1	00, 01~0A (Off, 1~10)
	KeyOff Effect	50	05	pp	1	00, 01~0A (Off, 1~10)
	Damper Noise	50	03	pp	1	00, 01~0A (Off, 1~10)
	Hammer Delay	50	07	pp	1	00, 01~0A (Off, 1~10)
	Fallback Noise	50	06	pp	1	00, 01~0A (Off, 1~10)

3.4 Setup Parameters: EDIT Menu (cont.)

Category	Parameter	Com.	Sub.	Part	Byte	Value (HEX)
8.VirtTech	Topboard	50	08	pp	1	00~03 (Close, Open1~3)
	Stereo Width	50	13	pp	1	00~7F
	KeyoffNoise	50	24	pp	1	00, 01~0A (Off, 1~10) <for E.PIANO sound>
	KeyOffNoiseDelay	50	25	pp	1	00~7F <for E.PIANO sound>
	Key Click Level	59	0E	pp	1	00, 01~0A (Off, 1~10) <for ORGAN sound>
	Wheel Noise Level	59	0F	pp	1	00~7F <for ORGAN sound>
9.Ch/Prog.	MIDI Transmit Channel	58	02	pp	1	00~0F (1~16Ch)
	Program Change Number	58	0B	pp	1	00~7F (1~128)
	Bank Number MSB	58	0E	pp	1	00~7F (0~127)
	Bank Number LSB	58	0F	pp	1	00~7F (0~127)
10.SETUP	Send Program On/Off	58	0A	pp	2	Send mode=00 (Program) /00, 01 (Off, On)
	Send Bank On/Off	58	0A	pp	2	Send mode=01 (Bank) /00, 01 (Off, On)
	Send Volume On/Off	58	0A	pp	2	Send mode=02 (Volume) /00, 01 (Off, On)
	Send Knobs On/Off	58	0A	pp	2	Send mode=03 (Knobs) /00, 01 (Off, On)
11.Transmit	Edit System Exclusive	58	09	7F	2	Trans. mode=04 (SysEX) /00, 01 (Off, On)
	Recorder	58	09	7F	2	Trans. mode=02 (Recorder) /00, 01 (Off, On)
	Fader Assign	54	01	7F	3	Fader#=0~3/Func.ID MSB/Func.ID LSB *<EXT>00/00~00/78
12.MMC	Transmit MMC	58	09	7F	2	Trans. mode=03 (MMC) /00, 01 (Off, On)
	MMC Device ID	58	0C	7F	2	ParaID=00 (DeviceID) /Value=00~7F
	MMC [RESET]	58	0C	7F	2	ParaID=01 (RESET) /Value=00 (NoAssign), 01~0D (MMC commands), 0E~10 (Realtime [FA,FB,FC])
	MMC [PLAY]	58	0C	7F	2	ParaID=02 (PLAY) /Value=00 (NoAssign), 01~0D (MMC commands), 0E~10 (Realtime [FA,FB,FC])
	MMC [REC]	58	0C	7F	2	ParaID=03 (REC) /Value=00 (NoAssign), 01~0D (MMC commands), 0E~10 (Realtime [FA,FB,FC])
	MMC [A<->B]	58	0C	7F	2	ParaID=04 (A<->B) /Value=00 (NoAssign), 01~0D (MMC commands), 0E~10 (Realtime [FA,FB,FC])
	MMC [REW]	58	0C	7F	2	ParaID=05 (REW) /Value=00 (NoAssign), 01~0D (MMC commands), 0E~10 (Realtime [FA,FB,FC])
	MMC [FF]	58	0C	7F	2	ParaID=06 (FF) /Value=00 (NoAssign), 01~0D (MMC commands), 0E~10 (Realtime [FA,FB,FC])

* Pedal/Wheel/Fader assign:
<INT> Mod., Pan., Exp., Damper, Soste., Soft, Reso., Cutoff, EFX1 Para1~10, EFX2 Para1~10
<EXT> CC#0~119, AfterTouch

** SW Button assign:
Oct.Layer, Rotary, Solo, Portament, Bend. Lock, Mod. Lock, Center Lock, Left Lock, EXP Lock, TW Control

3.5 Setup Parameters: SYSTEM Menu

Category	Parameter	Com.	Sub Com.	Part	Byte	Value (HEX)
Utility	System Tune	51	03	7F	1	26~40~5A (427.0~440.0~453.0Hz)
	Effect SW Mode	51	23	7F	1	00~02 (Preset, Temporary, Fixed)
	Knob Action	51	21	7F	2	Mode=01 (Knob) /Value=00, 01 (Normal, Catch)
	Volume (Fader) Action	51	21	7F	2	Mode=00 (Fader) /Value=00, 01 (Normal, Catch)
	LCD Contrast	51	20	7F	2	Mode=00 (Contrast) /Value=01~0A (1~10)
	LCD Reverse	51	20	7F	2	Mode=02 (Reverse) /Value=00, 01 (Off, On)
	Input Level	51	0D	7F	1	2E~40~52 (-18~0~+18dB)
	Audio Out Mode	51	0E	7F	1	00, 01 (Stereo, 2xMono)
	Lock SW Mode	51	22	7F	1	00~05 (Panel, Bender, Mod.Wheel, CenterPedal, LeftPedal, EXP)
	Auto Power Off	51	00	7F	1	00~03 (Off, 15min., 60min., 120min.)
	SW1 Mode	54	06	7F	2	Cont.ID=0B (SW1) /00~02 (Normal, Setup+, Setup-)
	SW2 Mode	54	06	7F	2	Cont.ID=0C (SW2) /00~02 (Normal, Setup+, Setup-)
Pedal/Mod.	Damper Pedal Mode	54	06	7F	2	Cont.ID=00 (Main Damper) /Value=00~04 (Normal, Setup+, Setup-, Playback, Metro.)
	Half Pedal Adjust	50	11	7F	1	01~0A (1~10)
	FSW Pedal Mode	54	06	7F	2	Cont.ID=05 (FSW1) /Value=00~04 (Normal, Setup+, Setup-, Playback, Metro.)
	FSW Pedal Polarity	54	07	7F	2	Cont.ID=05 (FSW1) /Value=00~01 (Normal, Reverse)
	Mod. Pedal Curve	54	08	7F	2	Cont.ID=0A (Wheel2<Mod. >) /Value=00~02 (Normal, Slow, Fast)
	EXP Pedal Curve	54	08	7F	2	Cont.ID=07 (EXP1) /Value=00~02 (Normal, Slow, Fast)
	Right Pedal Mode	54	06	7F	2	Cont.ID=01 (Sub Damper) /Value=00~04 (Normal, Setup+, Setup-, Playback, Metro.)
	Center Pedal Mode	54	06	7F	2	Cont.ID=03 (Sostenuto) /Value=00~04 (Normal, Setup+, Setup-, Playback, Metro.)
	Left Pedal Mode	54	06	7F	2	Cont.ID=04 (Soft) /Value=00~04 (Normal, Setup+, Setup-, Playback, Metro.)
MIDI	System Channel	58	00	7F	1	00~0F (1~16Ch.)
	Key to MIDI	58	08	7F	2	ToMIDI= bit2:USB, bit1:MIDI, bit0:Key/ToUSB=bit1:MIDI, bit0:Key (1:Connect)
	Key to USB-MIDI					
	MIDI to MIDI					
	MIDI to USB-MIDI					
	USB-MIDI to MIDI					
	Send Program On/Off	58	0A	7F	2	Send mode=00 (Program) /00, 01 (Off, On)
	Send Bank On/Off	58	0A	7F	2	Send mode=01 (Bank) /00, 01 (Off, On)
	Send Volume On/Off	58	0A	7F	2	Send mode=02 (Volume) /00, 01 (Off, On)
	Send Knobs On/Off	58	0A	7F	2	Send mode=03 (Knobs) /00, 01 (Off, On)
	Receive Mode	58	05	7F	1	00~02 (Panel, Multi, OmniOn)
	Program Mode	58	06	7F	1	Panel, GM
	Receive Ch1	58	04	7F	2	MIDI Ch.=00~0F (1~16Ch.) /Value=00~05 (On, Off, Main, Sub1~3)
	Receive Ch2					
	Receive Ch3					
Receive Ch4						
Receive Ch5						
Receive Ch6						
Receive Ch7						
Receive Ch8						
Receive Ch9						

3.5 Setup Parameters: SYSTEM Menu (cont.)

Category	Parameter	Com.	Sub Com.	Part	Byte	Value (HEX)
MIDI	Receive Ch10	58	04	7F	2	MIDI Ch.=00~0F (1~16Ch.) /Value=00~05 (On, Off, Main, Sub1~3)
	Receive Ch11					
	Receive Ch12					
	Receive Ch13					
	Receive Ch14					
	Receive Ch15					
	Receive Ch16					
Offset	Reverb Offset	55	03	7F	1	00~64 (0~100%)
	EQ Offset	51	24	7F	1	00, 01 (Off, On)
	EQ Offset Lo	51	25	7F	1	36~40~4A (-10 ~ +0 ~ +10dB)
	EQ Offset Hi	51	26	7F	1	36~40~4A (-10 ~ +0 ~ +10dB)
	EQ Offset Mid1	51	27	7F	1	36~40~4A (-10 ~ +0 ~ +10dB)
	EQ Offset Mid2	51	28	7F	1	36~40~4A (-10 ~ +0 ~ +10dB)

3.6 Assignable Knob Parameters

Knob Assignable Parameter			Data (HEX)	Sound Type				
Section	Category	Name	MSB/LSB	Piano	E.Piano	T.Wheel	Others	
Internal	1.REVERB	<input checked="" type="checkbox"/> Rev.Type	00/01			●		
		<input checked="" type="checkbox"/> RevPreDly	00/02			●		
		<input checked="" type="checkbox"/> Rev.Time	00/03			●		
		Rev.Depth	00/04	●	●	●	●	
	2.EFX/AMP	EFX Categ.	00/05	●	●	●	●	
		EFX Type	00/06	●	●	●	●	
		EFX Para1	00/07	●	●	●	●	
		EFX Para2	00/08	●	●	●	●	
		EFX Para3	00/09	●	●	●	●	
		EFX Para4	00/0A	●	●	●	●	
		EFX Para5	00/0B	●	●	●	●	
		EFX Para6	00/0C	●	●	●	●	
		EFX Para7	00/0D	●	●	●	●	
		EFX Para8	00/0E	●	●	●	●	
		EFX Para9	00/0F	●	●	●	●	
		EFX Para10	00/10	●	●	●	●	
		EFX2 Categ.	00/11	●	●	●	●	
		EFX2 Type	00/12	●	●	●	●	
		EFX2 Para1	00/13	●	●	●	●	
		EFX2 Para2	00/14	●	●	●	●	
		EFX2 Para3	00/15	●	●	●	●	
		EFX2 Para4	00/16	●	●	●	●	
		EFX2 Para5	00/17	●	●	●	●	
		EFX2 Para6	00/18	●	●	●	●	
		EFX2 Para7	00/19	●	●	●	●	
		EFX2 Para8	00/1A	●	●	●	●	
		EFX2 Para9	00/1B	●	●	●	●	
		EFX2Para10	00/1C	●	●	●	●	
		Amp Type	00/1D	●	●	●	●	
		Amp Drive	00/1F	●	●	●	●	
		Amp Level	00/1E	●	●	●	●	
		AmpEQ-Lo	00/20	●	●	●	●	
		AmpEQ-Mid	00/21	●	●	●	●	
		AmpEQ-Hi	00/22	●	●	●	●	
		MidFreq.	01/1A	●	●	●	●	
		AmpMicType	01/15	●	●	●	●	
	AmpMicPos.	01/14	●	●	●	●		
	AmpAmbien.	01/16	●	●	●	●		
	3.Sound	<input checked="" type="checkbox"/> MasterVol	00/23			●		
		Panpot	00/24	●	●	-	●	
Cutoff		00/25	●	●	-	●		
Resonance		00/26	●	●	-	●		
DCA Attack		00/27	●	●	-	●		
DCA Decay		00/28	●	●	-	●		
DCASustain		00/29	●	●	-	●		
DCARelease		00/2A	●	●	-	●		

3.6 Assignable Knob Parameters (cont.)

Knob Assignable Parameter			Data (HEX)	Sound Type			
Section	Category	Name	MSB/LSB	Piano	E.Piano	T.Wheel	Others
Internal	3.Sound	DCF ATK Tm	00/2B	●	●	-	●
		DCF ATK Lv	00/2C	●	●	-	●
		DCF Decay	00/2D	●	●	-	●
		DCFSustain	00/2F	●	●	-	●
		DCFRelease	00/2E	●	●	-	●
		DCF TchDpt	00/30	●	●	-	●
		DCA TchDpt	00/31	●	●	-	●
		Vib.Depth	00/32	●	●	-	●
		Vib.Rate	00/33	●	●	-	●
		Vib.Delay	00/34	●	●	-	●
		Octave	00/35	●	●	-	●
		Oct.Level	00/36	●	●	-	●
		Oct.Range	00/37	●	●	-	●
		Oct.Detune	00/38	●	●	-	●
		Portament	00/39	●	●	-	●
		Porta.Time	00/3A	●	●	-	●
		Porta.Mode	00/3B	●	●	-	●
	4.Tuning	Fine Tune	00/4B	●	●	●	●
		Stretch	00/4C	●	●	-	●
		Temperment	00/4D	●	●	-	●
		Temper.Key	00/4E	●	●	-	●
	5.KeySetup	Touch	00/55	●	●	-	●
		Dynamics	00/5B	●	●	-	●
		Trigger	00/56	●	●	●	●
		Min.Touch	01/1C	●	●	-	●
		OctavShift	00/57	●	●	●	●
		ZoneTrans.	00/58	●	●	●	●
		KS-Damping	00/59	●	●	-	●
		KS-Key	00/5A	●	●	-	●
		Zone Lo	00/52	●	●	●	●
		Zone Hi	00/51	●	●	●	●
		VeloSW	00/53	●	●	-	●
		VeloSW Val	00/54	●	●	-	●
		Solo	00/5C	●	●	-	●
		Solo Mode	00/5D	●	●	-	●
		KeyVolume	01/1B	●	●	-	●
	6.Control	DamperPed.	00/5E	●	●	●	●
		<input type="checkbox"/> D.Assign	00/5F			●	
		Right Ped.	00/61	●	●	●	●
		<input type="checkbox"/> R.Assign	00/62			●	
		Damp.Mode	00/60	●	●	●	●
		CenterPed.	00/63	●	●	●	●
		<input type="checkbox"/> C.Assign	00/64			●	
		Left Pedal	00/65	●	●	●	●
		<input type="checkbox"/> L.Assign	00/66			●	
SoftPdIDpt		01/03	●	●	-	●	

3.6 Assignable Knob Parameters (cont.)

Knob Assignable Parameter			Data (HEX)	Sound Type				
Section	Category	Name	MSB/LSB	Piano	E.Piano	T.Wheel	Others	
Internal	6.Control	Pitch Bend	00/69	●	●	-	●	
		Bend Range	00/6A	●	●	-	●	
		Mod.Wheel	00/6B	●	●	●	●	
		Mod.Assign	00/6C	●	●	●	●	
		Mod.Range	01/18	●	●	-	●	
		SW1	00/6D	●	●	●	●	
		<input checked="" type="checkbox"/> SW1Assign	00/6E				●	
		SW2	00/6F	●	●	●	●	
		<input checked="" type="checkbox"/> SW2Assign	00/70				●	
		FSW Pedal	01/1E	●	●	●	●	
		<input checked="" type="checkbox"/> FSWAssign	01/1F				●	
		EXP Pedal	00/67	●	●	●	●	
		<input checked="" type="checkbox"/> EXPAssign	00/68				●	
		8.VirtTech	Voicing	00/79	●	-	-	-
	StringReso		00/7B	●	-	-	-	
	UndampedRs		01/1D	●	-	-	-	
	DamperReso		00/7C	●	-	-	-	
	KeyOffEff.		00/7D	●	-	-	-	
	DamperNois		00/7E	●	-	-	-	
	HammerDly		00/7F	●	-	-	-	
	FallbackNs		01/00	●	-	-	-	
	Topboard		01/01	●	-	-	-	
	StereoWdth		00/7A	●	-	-	-	
	KeyOffNois		01/05	-	●	-	-	
	KeyOffDly		01/06	-	●	-	-	
	KeyClick		00/49	-	-	●	-	
	WheelNois	00/4A	-	-	●	-		
External	CC#0~119		00/00~00/77	* Harpsi./Bass sounds also have KeyOffNois/ KeyOffDly parameters.				
	AfterTouch		00/78	* MP7SE's EFX2/AMP parameters can be used by MAIN ZONE only.				

4 SOUND/SETUP Program/Bank

If the Receive Mode MIDI parameter is set to Panel (page 110), the MP7SE receives MIDI data on the System Channel only. To change internal sounds via MIDI, please refer to the Program Change Number List (page 154).

* Note: If the MP7SE receives the Program Number from 1 to 128 and Bank number MSB 0 or 1 in the System Channel, the MP7SE will switch to SETUP mode and the corresponding SETUP is recalled. When the Receive Mode is Section, the MP7SE can be received to each internal sound sections individually.

4.1 SETUP Program Number Table

Upper	Second	Third	Prog#:MSB-LSB
1	1	A	001:000-002
1	1	B	002:000-002
1	1	C	003:000-002
1	1	D	004:000-002
1	2	A~D	005:000-002 ~ 008:000-002
1	3	A~D	009:000-002 ~ 012:000-002
1	4	A~D	013:000-002 ~ 016:000-002
1	5	A~D	017:000-002 ~ 020:000-002
1	6	A~D	021:000-002 ~ 024:000-002
1	7	A~D	025:000-002 ~ 028:000-002
1	8	A~D	029:000-002 ~ 032:000-002
2	1~8	A~D	033:000-002 ~ 064:000-002
3	1~8	A~D	065:000-002 ~ 096:000-002
4	1~8	A~D	097:000-002 ~ 128:000-002
5	1~8	A~D	001:000-003 ~ 032:000-003
6	1~8	A~D	033:000-003 ~ 064:000-003
7	1~8	A~D	065:000-003 ~ 096:000-003
8	1~8	A~D	097:000-003 ~ 128:000-003

5 Program Change Number List

	Name	Program Mode = Panel			Program Mode = GM		
		Prg.	MSB	LSB	Prg.	MSB	LSB
PIANO	SK Concert Grand	1	0	0	1	121	0
	SK Studio Grand	2	0	0	1	121	1
	SK Mellow Grand	3	0	0	1	121	2
	Standard Grand	4	0	0	1	95	16
	EX Concert Grand	5	0	0	1	95	27
	EX Studio Grand	6	0	0	1	95	28
	EX Mellow Grand	7	0	0	1	95	29
	EX Jazz Grand	8	0	0	1	95	8
	SK-5 Grand	9	0	0	1	95	30
	SK-5 StudioGrand	10	0	0	1	95	31
	SK-5 MellowGrand	11	0	0	1	95	32
	Studio Grand	12	0	0	1	95	17
	Upright Piano	13	0	0	1	95	25
	Bright Upright	14	0	0	1	95	26
	Old Upright	15	0	0	1	95	34
	Honky Tonk	16	0	0	4	121	0
	Pop Piano	17	0	0	2	95	10
	Bright Pop Piano	18	0	0	2	95	13
	Pop Piano 2	19	0	0	2	95	11
	Pop Piano 3	20	0	0	2	95	12
	Modern Piano	21	0	0	2	121	0
	Mono SK-EX Grand	22	0	0	1	95	20
	Mono EX Grand	23	0	0	1	95	21
	GM Piano	24	0	0	2	95	6
	Rock Piano	25	0	0	2	121	1
	Piano Oct.	26	0	0	1	95	1
	Piano & EP	27	0	0	2	95	1
	New Age Piano	28	0	0	1	95	9
	Harpsichord	29	0	0	7	121	3
	Harpsichord2	30	0	0	7	121	0
	Harpsi. Octave	31	0	0	7	121	1
	Harpsi & Clavi	32	0	0	7	95	5
E.PIANO	Classic EP	33	0	0	5	121	0
	Classic EP 2	34	0	0	5	95	3
	Classic EP 3	35	0	0	5	95	5
	Classic EP 4	36	0	0	5	121	1
	Modern EP	37	0	0	6	121	0
	Modern EP 2	38	0	0	6	121	1
	Modern EP 3	39	0	0	6	121	2
	Modern EP 4	40	0	0	6	95	5
	60's EP	41	0	0	5	121	3
	60's EP 2	42	0	0	5	95	4
	Electric Grand	43	0	0	3	121	0
	Electric GP 2	44	0	0	3	121	1
	Dolce EP	45	0	0	5	95	2
	Legend EP	46	0	0	6	121	3
	Phase EP	47	0	0	6	121	4
	Classic EP 5	48	0	0	5	121	2
	Crystal EP	49	0	0	6	95	1
	New Age EP	50	0	0	6	95	2
	New Age EP2	51	0	0	6	95	3
	New Age EP3	52	0	0	6	95	4
	Clavinet	53	0	0	8	121	0
	Synth Clavinet	54	0	0	8	121	1
	Clavi & Marim	55	0	0	8	95	1
	Clavi Phaser	56	0	0	8	95	2
	Vibraphone	57	0	0	12	121	0
	Celesta	58	0	0	9	121	0
	Music Box	59	0	0	11	121	0
	Toy Piano	60	0	0	11	95	1
	Marimba	61	0	0	13	121	0
	Xylophone	62	0	0	14	121	0
	Steel Drums	63	0	0	115	121	0
	Bells	64	0	0	15	95	3

	Name	Program Mode = Panel			Program Mode = GM			
		Prg.	MSB	LSB	Prg.	MSB	LSB	
DRAWBAR	T.Wheel 1-A	65	0	0	18	95	112	
	T.Wheel 1-B	66	0	0	18	95	113	
	T.Wheel 1-C	67	0	0	18	95	114	
	T.Wheel 1-D	68	0	0	18	95	115	
	T.Wheel 2-A	69	0	0	17	95	112	
	T.Wheel 2-B	70	0	0	17	95	113	
	T.Wheel 2-C	71	0	0	17	95	114	
	T.Wheel 2-D	72	0	0	17	95	115	
	T.Wheel 3-A	73	0	0	20	95	112	
	T.Wheel 3-B	74	0	0	20	95	113	
	T.Wheel 3-C	75	0	0	20	95	114	
	T.Wheel 3-D	76	0	0	20	95	115	
	Blues Organ	77	0	0	17	121	0	
	Drawbar Organ	78	0	0	17	95	1	
	Drawbar Organ2	79	0	0	17	95	2	
	Gospel Organ	80	0	0	17	95	3	
	Ballad Organ	81	0	0	17	95	5	
	Soft Solo	82	0	0	17	95	8	
	Odd Man	83	0	0	17	95	6	
	Be Nice	84	0	0	17	95	7	
	Jazz Organ	85	0	0	18	121	0	
	Drawbar Organ3	86	0	0	18	121	2	
	Perc. Organ	87	0	0	18	95	15	
	Perc. Organ 2	88	0	0	18	121	1	
	Drawbar Organ4	89	0	0	17	121	3	
	Full Organ	90	0	0	18	95	4	
	Jazzer	91	0	0	18	95	1	
	Jazz Organ 2	92	0	0	18	95	12	
	Rock Organ 2	93	0	0	19	121	0	
	Rock Organ	94	0	0	18	95	13	
	Drawbar Organ5	95	0	0	17	121	1	
	Screamin'	96	0	0	17	95	4	
	ORGAN	Church Organ	97	0	0	20	121	0
		Full Pipes	98	0	0	20	95	9
		Full Ensemble	99	0	0	21	95	10
		Church Organ 2	100	0	0	20	121	1
		PrincipleChoir	101	0	0	20	95	23
		Small Ensemble	102	0	0	20	95	8
		Small Ens. 2	103	0	0	20	95	25
		Baroque	104	0	0	20	95	19
		Chiffy Tibia	105	0	0	20	95	17
		8'&4'Principle	106	0	0	20	95	24
		Stopped Pipe	107	0	0	20	95	21
		Principle Pipe	108	0	0	20	95	22
		8' Celeste	109	0	0	20	95	5
		Diapason	110	0	0	20	95	6
		Voice Celeste	111	0	0	20	95	39
		Baroque Mix	112	0	0	20	95	7
Reeds		113	0	0	20	95	10	
8' Reed		114	0	0	21	95	1	
Reed Pipes		115	0	0	20	95	26	
Posaune		116	0	0	20	95	27	
Theater Organ		117	0	0	20	95	2	
Theater Organ2		118	0	0	20	95	3	
Theater Organ3		119	0	0	20	95	4	
Theater Tibia		120	0	0	20	95	36	
Elec. Organ		121	0	0	17	95	9	
Elec. Organ 2		122	0	0	17	95	10	
60's Organ		123	0	0	17	121	2	
Pump Organ		124	0	0	20	95	40	
Fr. Accordion		125	0	0	22	121	0	
TangoAccordion		126	0	0	24	121	0	
Harmonica		127	0	0	23	121	0	
Kenban Harmo.		128	0	0	23	95	4	

	Name	Program Mode = Panel			Program Mode = GM		
		Prg.	MSB	LSB	Prg.	MSB	LSB
STRINGS / VOCAL	String Pad	1	0	1	49	95	8
	Warm Strings	2	0	1	49	95	1
	Warm Strings 2	3	0	1	51	121	0
	Synth Strings	4	0	1	52	121	0
	Beautiful Str.	5	0	1	45	95	1
	String Ens.	6	0	1	49	121	0
	String Ens. 2	7	0	1	50	121	0
	Full Orchestra	8	0	1	49	95	12
	Small Str. Ens	9	0	1	49	95	13
	Quartet	10	0	1	49	95	11
	Str. Bass Ens.	11	0	1	44	121	0
	Str. Sustain	12	0	1	49	95	10
	Pizzicato	13	0	1	46	121	0
	TremoloStrings	14	0	1	45	121	0
	Str. Sforzando	15	0	1	49	95	9
	Orchestra Hit	16	0	1	56	121	0
	Passionate Vln	17	0	1	41	121	0
	Classic Violin	18	0	1	41	95	3
	Passionate Vc	19	0	1	43	121	0
	Classic Cello	20	0	1	43	95	4
	Choir	21	0	1	53	121	0
	Breathy Choir	22	0	1	53	95	1
	Pop Aahs	23	0	1	53	121	1
	Slow Choir	24	0	1	53	95	2
	Jazz Ensemble	25	0	1	54	95	2
	Female Scat	26	0	1	54	95	22
	Pop Ensemble	27	0	1	54	121	0
	Contemp Ens.	28	0	1	54	95	10
	Itopia	29	0	1	92	121	1
	Halo Pad	30	0	1	95	121	0
	Halo Pad 2	31	0	1	95	95	1
	Synth Vocals	32	0	1	55	121	0
BRASS / WIND	Exp Brass	33	0	1	62	95	8
	Exp Saxes	34	0	1	66	95	11
	Tp&Bone&Tenor	35	0	1	58	95	11
	Flugel & Tenor	36	0	1	57	95	18
	Brass Section	37	0	1	62	121	0
	Synth Brass	38	0	1	63	121	0
	Synth Brass 2	39	0	1	64	121	0
	Jump Brass	40	0	1	63	121	3
	Exp Trumpet	41	0	1	57	121	0
	PlungerTrumpet	42	0	1	57	95	7
	Trumpet Shake	43	0	1	57	95	6
	Harmon Mute Tp	44	0	1	60	121	0
	Exp Trombone	45	0	1	58	121	0
	Lead Trombone	46	0	1	58	95	2
	PlungerTrombon	47	0	1	58	95	4
	ClosedMuteBone	48	0	1	58	95	9
	Exp Alto	49	0	1	66	121	0
	Lead Alto	50	0	1	66	95	2
	Soft Alto	51	0	1	66	95	7
	Lead Soprano	52	0	1	65	121	0
	Exp Tenor	53	0	1	67	121	0
	Ballad Tenor	54	0	1	67	95	6
	Growl Tenor	55	0	1	67	95	4
	Baritone Sax	56	0	1	68	121	0
	Exp Flute	57	0	1	74	95	12
	Ballad Flute	58	0	1	74	121	0
	Flute Overblow	59	0	1	74	95	9
	Flute Flutter	60	0	1	74	95	10
	Oboe	61	0	1	69	121	0
	Bassoon	62	0	1	71	121	0
	Jazz Clarinet	63	0	1	72	121	0
	Pan Flute	64	0	1	76	121	0

	Name	Program Mode = Panel			Program Mode = GM		
		Prg.	MSB	LSB	Prg.	MSB	LSB
PAD / SYNTH	Pad 1	65	0	1	90	95	3
	Pad 2	66	0	1	90	95	4
	Pad 3	67	0	1	90	95	5
	Saw Pad	68	0	1	90	95	7
	Pad 4	69	0	1	90	95	6
	Bowed Pad	70	0	1	93	95	1
	NoisyPad	71	0	1	96	95	3
	Sweep Pad	72	0	1	96	95	2
	Saw Lead LP24	73	0	1	82	95	1
	Saw Lead LP12	74	0	1	82	95	2
	Saw Lead HP	75	0	1	82	95	3
	Saw Lead BP	76	0	1	82	95	4
	Square Lead LP24	77	0	1	81	95	1
	Square Lead LP12	78	0	1	81	95	2
	Square Lead HP	79	0	1	81	95	3
	Square Lead BP	80	0	1	81	95	4
	Pulse Lead LP24	81	0	1	81	95	5
	Pulse Lead LP12	82	0	1	81	95	6
	Pulse Lead HP	83	0	1	81	95	7
	Pulse Lead BP	84	0	1	81	95	8
	Polysynth	85	0	1	82	95	5
	PolysynthOct	86	0	1	82	95	6
	SqrPoly	87	0	1	81	95	9
	Warm Lead	88	0	1	81	95	10
	Oct Saw	89	0	1	82	95	7
	Oct Pulse	90	0	1	81	95	11
	Saw HPF	91	0	1	82	95	8
	Sqr QTC	92	0	1	81	95	12
	Noise UpDown	93	0	1	123	95	1
	Noise Open	94	0	1	123	95	2
	Resonance Voice	95	0	1	123	95	3
	Resonance Rise	96	0	1	123	95	4
BASS / GUITAR	Acc. Bass	97	0	1	33	121	0
	Acc. Bass&Ride	98	0	1	33	95	1
	Electric Bass	99	0	1	34	95	1
	Electric Bass2	100	0	1	34	95	4
	Finger Bass	101	0	1	34	121	0
	FingerSlapBass	102	0	1	34	121	1
	Pick Bass	103	0	1	35	121	0
	Fretless Bass	104	0	1	36	121	0
	Synth Bass	105	0	1	39	121	0
	Synth Bass 2	106	0	1	40	121	0
	Rubber Bass	107	0	1	40	121	2
	Warm SynthBass	108	0	1	39	121	1
	Exp. Nylon Gtr	109	0	1	25	121	0
	Pick Nylon Gtr	110	0	1	25	95	3
	Exp Guitar	111	0	1	26	121	0
	Exp Guitar 2	112	0	1	26	95	11
	Rhythm Guitar	113	0	1	28	121	0
	Overdrive	114	0	1	30	121	0
	Distortion	115	0	1	31	121	0
	Muted Electric	116	0	1	29	121	0
	Pedal Steel	117	0	1	27	121	1
	HawaiianGuitar	118	0	1	27	95	1
	Jazz Guitar	119	0	1	27	121	0
	Jazz Guitar 2	120	0	1	27	95	2
	Banjo	121	0	1	106	121	0
	Mandolin	122	0	1	26	121	2
	Sitar	123	0	1	105	121	0
	Harp	124	0	1	47	121	0
	Ambience Set	125	0	1	33	120	0
	Plutonium Set	126	0	1	1	120	0
	Room Set	127	0	1	9	120	0
	Analogue Set	128	0	1	26	120	0

MIDI Implementation

Name	Program Mode = GM		
	Prg.	MSB	LSB
Wide Honky Tonk	4	121	1
Wide Harpsichord	7	121	2
Glocken	10	121	0
Wide Vibraphone	12	121	1
Wide Marimba	13	121	1
Tubular Bells	15	121	0
Church Bells	15	121	1
Carillon	15	121	2
Dulcimer	16	121	0
Church Organ 3	20	121	2
Reed Organ	21	121	0
Puff Organ	21	121	1
Accordion	22	121	1
Ukulele	25	121	1
Nylon Acoustic2	25	121	2
Nylon Acoustic3	25	121	3
12 String	26	121	1
Steel Guitar 2	26	121	3
E. Guitar 2	28	121	1
Rhythm Guitar	28	121	2
Cutting Guitar2	29	121	1
E. Guitar 3	29	121	2
Country Lead	29	121	3
Dynmic Ov.drive	30	121	1
Dist Feedback	31	121	1
Dist Rhythm	31	121	2
E.Gtr Harmonics	32	121	0
Guitar Feedback	32	121	1
Slap Bass	37	121	0
Slap Bass 2	38	121	0
Synth Bass 3	39	121	2
Clavi Bass	39	121	3
Hammer Bass	39	121	4
Synth Bass 4	40	121	1
Attack Bass	40	121	3
Slow Violin	41	121	1
Viola	42	121	0
Celtic Harp	47	121	1
Timpani	48	121	0
Strings & Brass	49	121	1
60's Strings	49	121	2
Synth Strings 3	51	121	1
Humming	54	121	1
Analog Voice	55	121	1
Bass Hit Plus	56	121	1
6th Hit	56	121	2
Euro Hit	56	121	3
Solo Trumpet	57	121	1
Trombone 2	58	121	1
Bright Trombone	58	121	2
Tuba	59	121	0
Muted Trumpet 2	60	121	1
French Horns	61	121	0
Warm FrenchHorn	61	121	1
Brass Section 2	62	121	1
Synth Brass 3	63	121	1

Name	Program Mode = GM		
	Prg.	MSB	LSB
Analog Brass	63	121	2
Synth Brass 4	64	121	1
Analog Brass 2	64	121	2
English Horn	70	121	0
Piccolo	73	121	0
Recorder	75	121	0
Blown Bottle	77	121	0
Shakuhachi	78	121	0
Whistle	79	121	0
Ocarina	80	121	0
Square Lead	81	121	0
Square 2	81	121	1
Sine	81	121	2
Classic Synth	82	121	0
Classic Synth2	82	121	1
Lead	82	121	2
Classic Synth 3	82	121	3
SequencedAnalog	82	121	4
Caliope	83	121	0
Chiff	84	121	0
Charang	85	121	0
Wire Lead	85	121	1
Voice	86	121	0
Fifth	87	121	0
Bass & Lead	88	121	0
Soft Wire Lead	88	121	1
New Age Pad	89	121	0
Warm Pad	90	121	0
Sine Pad	90	121	1
Polysynth	91	121	0
Itopia	92	121	0
Bowed Pad	93	121	0
Metallic	94	121	0
Multi Sweep	96	121	0
Rain Pad	97	121	0
Soundtrack	98	121	0
Crystal	99	121	0
Synth Mallet	99	121	1
Atmosphere	100	121	0
Brightness	101	121	0
Goblin	102	121	0
Echoes	103	121	0
Echo Bell	103	121	1
Echo Pan	103	121	2
Sci-Fi	104	121	0
Sitar 2	105	121	1
Shamisen	107	121	0
Koto	108	121	0
Taisho Koto	108	121	1
Kalimba	109	121	0
Bag Pipe	110	121	0
Fiddle	111	121	0
Shanai	112	121	0
Tinkle Bell	113	121	0
Agogo	114	121	0
Woodblock	116	121	0

Name	Program Mode = GM		
	Prg.	MSB	LSB
Castanet	116	121	1
Taiko Drums	117	121	0
Concert BD	117	121	1
Melodic Toms	118	121	0
Melodic Toms 2	118	121	1
Synth Drum	119	121	0
Rhythm Box Tom	119	121	1
Electric Drum	119	121	2
Reverse Cymbal	120	121	0
Gtr Fret Noise	121	121	0
GtrCuttingNoise	121	121	1
Ac Bass Slap	121	121	2
Breath Noise	122	121	0
Flute Key Click	122	121	1
Seashore	123	121	0
Rain	123	121	1
Thunder	123	121	2
Wind	123	121	3
Stream	123	121	4
Bubble	123	121	5
Bird Tweet	124	121	0
Dog Barking	124	121	1
Horse Gallop	124	121	2
Bird Tweet 2	124	121	3
Telephone	125	121	0
Telephone 2	125	121	1
Door Creak	125	121	2
Door Slam	125	121	3
Scratch	125	121	4
Wind Chime	125	121	5
Helicopter	126	121	0
Car Engine	126	121	1
Car Stopping	126	121	2
Car Passing	126	121	3
Car Crash	126	121	4
Siren	126	121	5
Train	126	121	6
Jet Plane	126	121	7
Starship	126	121	8
Burst Noise	126	121	9
Applause	127	121	0
Laughing	127	121	1
Screaming	127	121	2
Punch	127	121	3
Heartbeat	127	121	4
Foot Step	127	121	5
Gunshot	128	121	0
Machine Gun	128	121	1
Laser Gun	128	121	2
Explosion	128	121	3
Power Set	17	120	0
Electronic Set	25	120	0
Brush Set	41	120	0
Orchestra Set	49	120	0
SFX Set	57	120	0

* MIDI sounds are not accessible from the panel.

6 Control Change Number (CC#) Table

Control Number		Control Function
Decimal	Hex	
0	0	Bank Select (MSB)
1	1	Modulation Wheel or lever
2	2	Breath Controller
3	3	(undefined)
4	4	Foot Controller
5	5	Portament Time
6	6	Data Entry (MSB)
7	7	Channel Volume
8	8	Balance
9	9	(undefined)
10	A	Panpot
11	B	Expression Controller
12	C	Effect Controller1
13	D	Effect Controller2
14	E	(undefined)
15	F	(undefined)
16-19	10-13	General Purpose Controller1~4
20-31	14-1F	(undefined)
32	20	Bank Select (LSB)
33-63	21-3F	(LSB of Control Number 1-32)
64	40	Hold1 (Damper Pedal or Sustain)
65	41	Portamento On/Off
66	42	Sostenuto
67	43	Soft Pedal
68	44	Legato Footswitch
69	45	Hold2 (freeze etc)
70	46	Sound Controller1 (Sound Variation)
71	47	Sound Controller2 (Filter Resonance/Harmonic Intensity)
72	48	Sound Controller3 (Release Time)
73	49	Sound Controller4 (Attack Time)
74	4A	Sound Controller5 (Brightness/Cutoff)
75	4B	Sound Controller6 (Decay Time)
76	4C	Sound Controller7 (Vibrato Rate)
77	4D	Sound Controller8 (Vibrato Depth)
78	4E	Sound Controller9 (Vibrato Delay)
79	4F	Sound Controller10
80-83	50-53	General Purpose Controller5~8
84	54	Portament Control
85-90	55-5A	(undefined)
91	5B	Effect1 Depth (Reverb Send Level)
92	5C	Effect2 Depth
93	5D	Effect3 Depth (Chorus Send Level)
94	5E	Effect4 Depth
95	5F	Effect5 Depth
96	60	Data Increment
97	61	Data Decrement
98	62	Non Registered Parameter Number (LSB)
99	63	Non Registered Parameter Number (MSB)
100	64	Registered Parameter Number (LSB)
101	65	Registered Parameter Number (MSB)
102-119	66-77	(undefined/reserved)
120-127	78-7F	Channel Mode Message

Function	Transmitted	Recognised		Remarks	
		Panel	Multi		
Basic Channel	Default	1 - 16	1 - 16	1 - 16	
	Changed	1 - 16	1 - 16	1 - 16	
Mode	Default	3	3	3	
	Messages	3,4 (m=1)	X	3,4 (m=1)	
	Altered	*****			
Note Number		0 - 127	0 - 127	0 - 127	
	True Voice	*****			
Velocity	Note ON	0 9nH, v=1 - 127	0	0	
	Note OFF	0 8nH, v=0 - 127	0	0	
After Touch	Key	X	X	X	
	Channel	0 *1	X	X	
Pitch Bend		0	0	0	
Control Change	0,32	0	0	0	Bank Select
	1	0	0	0	Modulation *2
	5,6,38	0	X	0	Portament Time,Data Entry
	7	0	0	0	Volume
	10,65	0	X	0	Panpot, Portament On/Off
	11	0	0	0	Expression (EXP) *2
	64	0	0	0	Hold1 (Damper) *2
	66	0	0	0	Sostenuto *2
	67	0	0	0	Soft *2
	70,71	0	X	0	Sustain, Resonance
	72,73,74,75	0	X	0	RLS, ATK, CTF, DCY
	76,77,78	0	X	0	Vibrato (Rate,Depth,Delay)
	91	0	X	0	Reverb Depth
	98,99	X	X	0	NRPN LSB/MSB
100, 101	0	0	0	RPN LSB/MSB	
0-119	0 *1	X	X		
Program Change		0	0	0	
	True #	*****	0 - 127	0 - 127	
System Exclusive		0	0	0	
Common	Song Position	X	X	X	
	Song Select	X	X	X	
	Tune	X	X	X	
System Real Time	Clock	X	X	X	
	Commands	0	X	X	
Other Functions	All Sound OFF	X	0	0	
	Reset All Cntrls	0	0	0	
	Local ON/OFF	X	X	X	
	All Note OFF	0	0 (123-127)	0 (123-127)	
	Active Sense	X	0	0	
	Reset	X	X	X	
Notes		*1: Assigned to Modulation Wheel, Foot Controllers or Knob A~D *2: ON/OFF settings of each section are set in EDIT menu. The function is assigned to MOD/EXP/Right/Centre/Left Pedal in EDIT menu. Also, the multi mode's other messages control each volume faders or each parameters in EDIT menu.			

Mode 1 : OMNI ON , POLY
Mode 3 : OMNI OFF, POLY

Mode 2 : OMNI ON , MONO
Mode 4 : OMNI OFF, MONO

0 : Yes
X : No

KAWAI

THE FUTURE OF THE PIANO

